



UNIVERSITY *of*  
TASMANIA



**IMAS**  
INSTITUTE FOR MARINE & ANTARCTIC STUDIES

# Developing cost-effective industry based techniques for monitoring puerulus settlement in all conditions: Phase2

Stewart Frusher, Graeme Ewing, Justin Rizari and Ruari Colqhoun

July 2018

FRDC Project No 2014/025



**FRDC**

FISHERIES RESEARCH &  
DEVELOPMENT CORPORATION

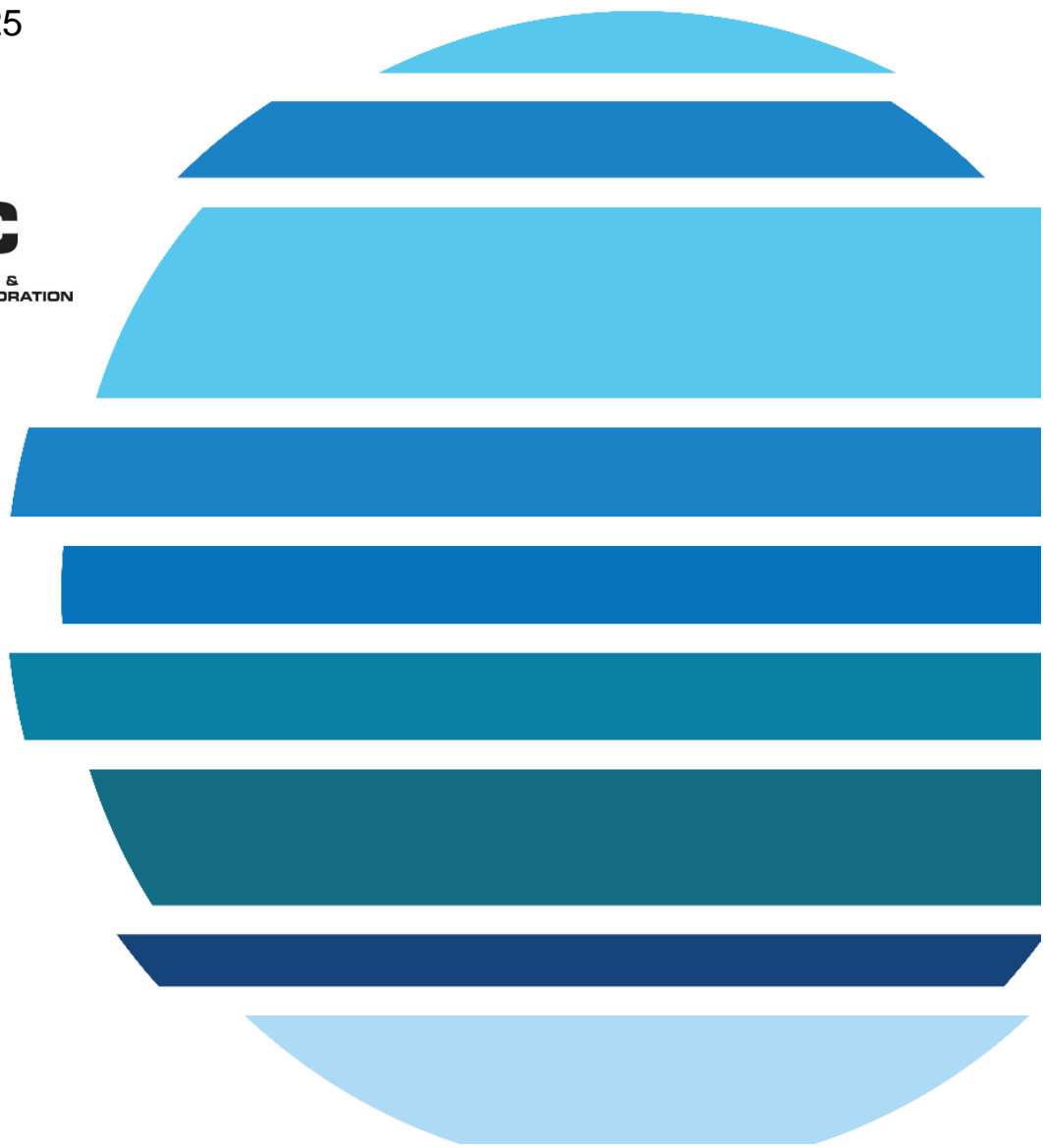

# **Developing cost-effective industry based techniques for monitoring puerulus settlement in all conditions: Phase2**

**Stewart Frusher, Graeme Ewing, Justin Rizari and Ruari Colqhoun**

**July 2018**

**FRDC Project No [2014/025]**



**FRDC**

**FISHERIES RESEARCH &  
DEVELOPMENT CORPORATION**

© Year Fisheries Research and Development Corporation.  
All rights reserved.

Print ISBN 978-1-925646-33-7

Electronic ISBN 978-1-925646-34-4

**Developing cost-effective industry based techniques for monitoring puerulus settlement in all conditions:  
Phase2  
2014/025  
2018**

### **Ownership of Intellectual property rights**

Unless otherwise noted, copyright (and any other intellectual property rights, if any) in this publication is owned by the Fisheries Research and Development Corporation [and if applicable insert research provider organisation/s e.g. CSIRO Marine Research]

This publication (and any information sourced from it) should be attributed to [Insert citation – Surname, Initial., Organisation, Year, Title – *in italics*, Place of publishing, Month. CC BY 3.0]

### **Creative Commons licence**

All material in this publication is licensed under a Creative Commons Attribution 3.0 Australia Licence, save for content supplied by third parties, logos and the Commonwealth Coat of Arms.



Creative Commons Attribution 3.0 Australia Licence is a standard form licence agreement that allows you to copy, distribute, transmit and adapt this publication provided you attribute the work. A summary of the licence terms is available from [creativecommons.org/licenses/by/3.0/au/deed.en](http://creativecommons.org/licenses/by/3.0/au/deed.en). The full licence terms are available from [creativecommons.org/licenses/by/3.0/au/legalcode](http://creativecommons.org/licenses/by/3.0/au/legalcode).

Inquiries regarding the licence and any use of this document should be sent to: [frdc@frdc.com.au](mailto:frdc@frdc.com.au)

### **Disclaimer**

The authors do not warrant that the information in this document is free from errors or omissions. The authors do not accept any form of liability, be it contractual, tortious, or otherwise, for the contents of this document or for any consequences arising from its use or any reliance placed upon it. The information, opinions and advice contained in this document may not relate, or be relevant, to a readers particular circumstances. Opinions expressed by the authors are the individual opinions expressed by those persons and are not necessarily those of the publisher, research provider or the FRDC.

The Fisheries Research and Development Corporation plans, invests in and manages fisheries research and development throughout Australia. It is a statutory authority within the portfolio of the federal Minister for Agriculture, Fisheries and Forestry, jointly funded by the Australian Government and the fishing industry.

### **Researcher Contact Details**

Name: Stewart Frusher  
Address: Nubeena Crescent,  
Taroona, Tasmania, 7053  
Phone: 03 277 277  
Fax: 03 278035  
Email: Stewart.Frusher@utas.edu.au

### **FRDC Contact Details**

Address: 25 Geils Court  
Deakin ACT 2600  
Phone: 02 6285 0400  
Fax: 02 6285 0499  
Email: [frdc@frdc.com.au](mailto:frdc@frdc.com.au)  
Web: [www.frdc.com.au](http://www.frdc.com.au)

In submitting this report, the researcher has agreed to FRDC publishing this material in its edited form.

# Contents

<b>Contents</b> .....	<b>iii</b>
<b>Acknowledgments</b> .....	<b>viii</b>
<b>Executive Summary</b> .....	<b>ix</b>
<b>Introduction</b> .....	<b>1</b>
Background .....	1
Objectives .....	2
<b>Methods</b> .....	<b>3</b>
Phase 2 collector design.....	3
Collector deployment.....	5
Collector servicing .....	8
More detailed servicing instructions are provided in appendix 4.....	8
Sample handling .....	8
Statistical Methods .....	8
Comparisons of collector designs .....	8
Phase 1 and phase 2 collectors .....	8
Traditional diver-serviced and Phase 1&2 deep water designs .....	8
Spatial and depth trends in settlement .....	8
Depth effects on puerulus settlement rates .....	9
Spatial effects on puerulus settlement rates .....	9
Temporal trends in settlement .....	9
Dissemination of design to beneficiaries .....	9
South Australia.....	9
New Zealand .....	9
Cost-benefit analysis to establish cost-effective future puerulus monitoring options.....	9
Value-adding.....	10
Temperature loggers.....	10
Species composition of collector catches.....	10
<b>Results</b> .....	<b>11</b>
Comparisons of collector designs .....	16
Phase 1 and phase 2 collectors .....	16
Traditional diver-serviced and Phase 1&2 deep water designs .....	17
Spatial and depth trends in settlement .....	18
Depth effects on puerulus settlement rates .....	18
Spatial effects on puerulus settlement rates .....	20
Temporal trends in settlement .....	22
Temporal depth trends in settlement .....	24
Dissemination of design to beneficiaries .....	27
South Australia.....	27

New Zealand .....	29
Cost-benefit analysis to establish cost-effective future puerulus monitoring.....	29
Value-adding.....	30
Temperature loggers.....	30
Species composition of collector catches.....	35
<b>Discussion.....</b>	<b>36</b>
Comparisons of collector designs.....	36
Spatial and depth trends in settlement .....	36
Depth .....	37
Region .....	38
Reef proximity.....	39
Temporal trends in settlement .....	39
Cost-benefit analysis to establish cost-effective future puerulus monitoring.....	40
Replicate or replace inshore monitoring with offshore fisher-serviced monitoring .....	40
Replicate or replace inshore monitoring with inshore fisher-serviced monitoring.....	40
Complement existing inshore monitoring with fisher-serviced offshore monitoring .....	40
Value-adding.....	41
Temperature loggers.....	41
Species Composition .....	42
Conclusions.....	43
<b>Implications .....</b>	<b>44</b>
<b>Recommendations .....</b>	<b>44</b>
<b>Further development .....</b>	<b>45</b>
<b>Extension and Adoption.....</b>	<b>45</b>
Project coverage.....	46
<b>Project materials developed .....</b>	<b>47</b>
<b>Appendices .....</b>	<b>48</b>
Appendix 1: Intellectual property .....	48
Appendix 2: Staff.....	49
Appendix 3 - Example graphics from the engineering plans for construction of deep water puerulus collectors .....	50
Appendix 4 – Data sheets and instructions supplied to participating fishers .....	52
Wheelhouse data sheet .....	52
Servicing Instructions.....	53
Appendix 5: Species list from fauna retained from collector servicing .....	54
Appendix 6: References.....	55
Appendix 7: Review of puerulus collectors.....	58
Appendix 8: Industry workshop.....	61
Outcomes from deep-water puerulus project workshop – 28/2/2012 .....	61

## Tables

Table 1. Number of collectors by region and depth.....	14
Table 2: Puerulus catches by season .....	15
Table 3. Parameter estimates of the generalised linear model (GLM) relating puerulus density to region and trap type .....	16
Table 4. Parameter estimates of the generalised linear model (GLM) relating puerulus density to collector type .....	17
Table 5. Parameter estimates of the generalised linear model (GLM) relating puerulus density to region and depth .....	18
Table 6. Parameter estimates of the generalised linear model (GLM) relating puerulus density to depth in the south and southwest combined.....	18
Table 7. Parameter estimates of the generalised linear model (GLM) relating puerulus density to region	20
Table 8. Parameter estimates of the generalised linear model (GLM) relating puerulus density to proximity to reef habitat.....	21
Table 9. Parameter estimates of the generalised linear model (GLM) relating puerulus density to season at DeWitt .....	22
Table 10. Parameter estimates of the generalised linear model (GLM) relating puerulus density to season in the Southwest .....	23
Table 11. Parameter estimates of the linear regression relating puerulus density to depth on the South/Southwest Tasmanian coast.....	24
Table 12: Parameter estimates of the generalised linear model (GLM) relating puerulus density to location and collector type in South Australia.....	28
Table 13: Puerulus catches from deployments in the South Australian northern lobster fishing zone of deep water puerulus collectors .....	28
Table 14: Estimates of the initial setup and ongoing annual costs associated for inshore diver-serviced and deep-water fisher-serviced puerulus monitoring programs.....	30

## Figures

Figure 1: Depiction of collector design and assembly .....	3
Figure 2: Mooring lines and floats .....	4
Figure 3: Depiction of collector deployments in strings .....	4
Figure 4: Map showing puerulus monitoring sites .....	5
Figure 5: South west collector sites .....	6
Figure 6: North west collector sites .....	6
Figure 7: North east collector sites .....	7
Figure 8: South east collector sites .....	7
Figure 9: ReefNet Sensus temperature and depth logger .....	10
Figure 10: Map showing puerulus monitoring sites .....	12
Figure 11: South collector sites .....	13
Figure 12: East collector sites .....	13
Figure 13: Comparison of mean catch rates of puerulus from the collector design .....	16
Figure 14: Comparison of mean catch rates of puerulus between deep water collectors and traditional diver-serviced collectors .....	17
Figure 15: Comparison of mean catch rates of puerulus by depth strata at the East and South coast regions. ....	19
Figure 16: Comparison of mean catch rates of puerulus by depth strata at the Southwest and South coast regions .....	19
Figure 17: Comparison of mean catch rates of puerulus collectors deployed on the South coast and the East coasts of Tasmania. ....	20
Figure 18: Comparison of mean catch rates of puerulus between deep-water collectors positioned on, near (within 200m), or far (beyond 1000m) from rocky reef habitats. ....	21
Figure 19: Comparison of mean catch rates of puerulus between deep-water collectors .....	22
Figure 20: Seasonal puerulus catch rates (puerulus per collector) on the south and south west coasts of Tasmania. ....	23
Figure 21: Correlation of catch densities (puerulus/collector) for bimonthly settlement on deep water collectors .....	25
Figure 22: Percentage relative standard errors (bars) of mean inshore and offshore puerulus catch rates (lines) by puerulus season. ....	26
Figure 23: Comparison of mean catch rates of puerulus between deep water collectors and traditional diver-serviced collectors at McClaren Point and Taylors Island in South Australia. ....	27
Figure 24: Water temperature by depth and date at south west sites. ....	30

Figure 25: Water temperature by depth and date at north west sites. ....	31
Figure 26: Water temperature by depth and date at north east sites. ....	31
Figure 27: Water temperature by depth and date at south east sites. ....	32
Figure 28: Water temperature by depth and date at eastern sites.....	32
Figure 29: Water temperature by depth and date at southern sites. ....	33
Figure 30: Water temperature at southern sites by date and season. ....	33
Figure 31: Mean seasonal water temperature from data loggers .....	34
Figure 32: Multidimensional scaling plot of taxa encountered on collectors .....	35



# Acknowledgments

The project was jointly funded by the Fisheries Research and Development Corporation (FRDC project 2011/025), and the Institute for Marine and Antarctic Studies, University of Tasmania. We acknowledge the support of the Tasmanian rock lobster commercial fishing industry in the development, deployment and servicing of the deep water collector designs. In particular, we wish to thank John Sansom, Kent Way, Troy Rainbird, Paul Jordan and Peter Warner for their direct involvement in this project.

We also wish to thank commercial fishers and researchers who assisted in trialling our collector design in South Australia (Kyri Toumazos – Executive Officer of the South Australia Northern Zone Rock Lobster Fishermen’s Association, and Adrian Linnane and Lachlan Macleay - South Australian Research and Development Institute) and in New Zealand (Daryl Sykes – NZ Rock Lobster Industry Council).

# Executive Summary

**2014/025 Developing cost-effective industry based techniques for monitoring puerulus settlement in all conditions: Phase2**

**Principal Investigator:** Professor Stewart Frusher

**Address:** Institute for Marine and Antarctic Studies  
University of Tasmania  
GPO Box 252-49 Hobart TAS 7001

**Telephone:** 0362277277

**Objectives:**

1. To determine an appropriate and cost effective sampling strategy (number of collectors, depth and time) to enable statistically meaningful analysis of spatial and depth trends in puerulus settlement.
2. To compare shallow and deep water survey methods (e.g. diver based, fisher servicing) to establish the most cost effective methods for on-going monitoring of puerulus settlement.

**Non-technical summary:**

This is the final report for the second phase of this project in which prototypes of cost-effective techniques for monitoring puerulus settlement designed in phase 1 (2011/020) were deployed more widely around the Tasmanian coast and in South Australia and New Zealand.

**Outcomes achieved to date**

The outputs from this second phase of the project have led to the following outcomes:

1. A refined puerulus collector design that:
  - Collects puerulus as effectively as traditional diver-serviced inshore collector systems
  - Collects puerulus effectively from deep water (>50m)
  - Can be easily and safely deployed, retrieved and serviced by vessels from the Tasmanian commercial lobster fleet during routine fishing operations
2. Deployments at various locations around the Tasmanian coast over 4 settlement seasons have shown that:
  - Puerulus settlement is considerably lower in deeper offshore waters than in shallow inshore waters although sufficient to demonstrate major changes in recruitment.
  - Puerulus settlement in deeper waters was higher in the 2016/2017 settlement season on the south coast of Tasmania than it was on the east coast
  - Puerulus settlement rates in deep waters varied between recent seasons similarly to settlement in inshore waters

3. A cost-benefit analysis comparing traditional diver-based and deep-water fisher serviced puerulus collection strategies has shown that:

- Fisher-serviced is more cost-effective than diver-based methods for similar arrays of collectors
- The current fisher-serviced design is not suitable for deployment in inshore shallow exposed waters due to sedimentation from mobile sediments
- The fisher-serviced collection system developed in this project is a cost-effective way to monitor puerulus settlement in deep water
- Despite yielding lower catch rates than inshore settlement monitoring, the number of offshore collectors used in this project displayed similar temporal patterns of settlement with similar statistical power.
- Offshore collectors retain puerulus settlers similarly to inshore collectors
- Fisher-serviced puerulus monitoring would be even more cost effective if industry agreed to provide support without the requirement for financial compensation

A review of the Tasmanian puerulus program undertaken in 2008 involving government, industry and an external review identified that the current puerulus collectors were all on the East Coast (with the exception of King Island); despite the southern and western regions supporting the largest catches in the fishery. The review identified as a priority to "investigate options for collection on the west coast using boat-based collection and using the commercial fleet to reduce cost of collection".

In phase 1 of this project a design for a deep water collector was developed through consultation with industry and prototypes of this design were constructed and tested in aquaria with captured pueruli, on the seafloor adjacent to an existing inshore shallow collector site on the east coast of Tasmania, and in deep water on the south and southwest coasts of Tasmania. The prototype collectors were successfully deployed, retrieved and serviced by vessels in the commercial lobster fleet and vessel masters reported that the design facilitated safe and efficient handling on deck. The prototypes collected significantly more puerulus than adjacent routine collectors in deployments at the shallow site and collected puerulus for the first time on the deeper and more exposed southwest coast of Tasmania.

This phase 2 of the project saw deployment of a refined collector design onto reefs around Tasmania over 2 puerulus settlement seasons and provided evidence that; (1) puerulus settle in larger numbers in shallow inshore waters; (2) puerulus settlement in deeper water varies in space, time and depth around the Tasmanian coast (eg. Puerulus settlement was higher on the south coast than on the east coast in the 2016/2017 settlement season and puerulus settlement in waters deeper than 100m appears to be very low).

When deployed alongside traditional diver based collectors, the fisher-serviced puerulus collector captures and retains more puerulus than traditional diver-based methods and is more cost-effective per collector. However, refinements to the design would be required for its use in inshore puerulus monitoring due to siltation issues from mobile sediments in exposed inshore locations.

Despite experiencing lower catch rates than inshore settlement monitoring, the number and consistence of settlement on offshore deeper water collectors enabled similar temporal patterns of settlement to be determined. The deep water collectors also retained puerulus for similar periods to the traditional collectors. Consequently, deep water puerulus collection is a feasible alternative to costly inshore diver-serviced monitoring programs and would be expected to indicate similar trends in recruitment. Industry involvement in servicing offshore collectors during routine fishing operations greatly increases the cost-

effectiveness of this approach; particularly if this support was provided without the requirement for financial compensation.

**Keywords**

Puerulus, larval settlement, deep water, lobster fisheries, industry monitoring

# Introduction

## Background

Rock lobster fisheries throughout southern Australia show substantial fluctuations in recruitment which if not carefully monitored and managed may lead to lost opportunity and substantial loss in revenue. In Australia, larval (puerulus) collectors have been established in shallow water regions to provide early warning of future changes in abundance. These collectors are serviced by research staff, either by diving (SA, Tas & Vic) or from dinghies (WA) which make them expensive to service and thus limited in their regional distribution to a few sites. For southern rock lobster in Tasmania there has been concern over how well the observed larval settlement represents the entire fishery as sampling sites are few and limited to the East Coast, whereas the majority of catch is from deeper reefs on the South and West Coasts where no collectors are deployed. To improve our understanding of the relationship between recruitment, future catches and short and long term recruitment trends, there is a need to improve spatial (region and depth) coverage. Previous attempts to deploy puerulus collectors in shallow regions in southern and western Tasmania, where over 60% of the catch is obtained, have failed due to weather conditions.

This project was developed to assist in the sustainable management of the southern rock lobster fishery in Tasmania. It addresses FRDC's strategic challenge to ensure that the Australian community derives optimal economic, environmental and social benefits from its fishery and aquaculture resources and addresses the themes of ecological sustainable development and climate change. This is achieved through an improved understanding of recruitment to the resource and in development of cost-effective monitoring systems that involve and engage the fishing industry. The project also addresses priorities from a recent review of the puerulus program undertaken in 2008. The two priorities identified by government, industry and an external reviewer were:

1. **Recruitment:** Poor recruitment on the east coast of Tasmania has resulted in declining effort in this region which was re-directed to the southern and western regions until a decrease in the quota was implemented. A recent report detailing the correlation between puerulus settlement and oceanographic conditions on the east coast of Tasmania has aided both industry and managers in understanding the current and potentially future outlook for the fishery in this region. Unfortunately, similar information does not exist for the southern and western regions of the fishery despite these regions being the major lobster fishing regions in Tasmania. Previous trials at deploying puerulus collectors in southern and western regions of Tasmania have been unsuccessful due to the rough weather and sea conditions. These trials had been in shallow water regions and in close proximity to boat launching ramps so that they could be serviced by Departmental staff at regular (monthly) intervals. The review identified as a priority "investigate options for collection on the west coast using boat-based collection."
2. **Cost-effectiveness:** Currently the puerulus monitoring program is an expensive component of the overall research budget as it involves a minimum of three divers and several days each month in the field. The project will also compare the deeper-water collectors against the shallow water collectors and it might prove more cost-effective to use either the industry to service collectors in the future or use collectors that do not require diving. The review identified as a priority to "investigate options for using the commercial fleet to reduce cost of collection".

To address these priorities for research, funding was sought from FRDC and this project was subsequently accomplished under two grants. Phase one *Developing cost-effective industry based techniques for monitoring puerulus settlement in all conditions: trials in southern and western Tasmania - Phase 1: Proof of concept (2011/020)* developed, with industry, a deep-water collector that could withstand the harsh weather conditions on Tasmania's west and southern coasts. The collectors were successful at collecting puerulus to the maximum depth the collectors were deployed: 110m (Ewing *et al.*, 2013). Phase one also investigated the potential and cost-effectiveness of an underwater camera system to monitor settlement. In collaboration with the CSIRO ICT Centre a camera system was successfully developed that was capable of relaying real-time pictures from puerulus collectors on the sea-floor to an online server via the 4G mobile phone network (Ewing *et al.*, 2013).

This report presents the results from the second phase of this project and attempts to determine whether the industry-serviced collectors are suitable for informing management decisions and if so, the number of puerulus collectors required to provide meaningful results to industry and managers on recruitment patterns and trends to the fishery in important regions of the fishery. This included both spatial and temporal resolution and also included results from settlement trials conducted in South Australia from collectors provided by this project. Phase 2 also included a cost benefit analysis undertaken to determine the relative costs of monitoring from the traditional diver-based inshore techniques against industry-serviced deep water collectors to gauge the cost-effectiveness of using industry-serviced collectors.

## Objectives

No.	Details
1	To determine an appropriate and cost effective sampling strategy (number of collectors, depth and time) to enable statistically meaningful analysis of spatial and depth trends in puerulus settlement.
2	To compare shallow and deep water survey methods (e.g. diver based, fisher servicing) to establish the most cost effective methods for on-going monitoring of puerulus settlement.

# Methods

Refinements were proposed for the collector design used in the phase 1 (P1) “proof of concept” FRDC project (Ewing *et al.*, 2013) through collaboration and feedback from commercial lobster fishers who participated in P1 sampling. These refinements were incorporated in the design and construction of the collector used in phase 2 (P2) of this project and a larger fleet of P2 collectors were constructed and distributed around the Tasmanian coast to investigate spatial and temporal patterns in puerulus settlement.

## Phase 2 collector design

The components of 56 P2 collectors were constructed by local Tasmanian fabricators, and lines and buoys were prepared in-house (see appendix 3, and Figs 1,2, and 3). Design considerations for the P2 collector included:

- Booth crevice collector substrate
- Similar dimensions to standard lobster pots to facilitate handling with standard lobster vessel deck equipment
- Self-righting when deployed onto the seafloor and sufficiently heavy to preclude movement in swell
- Robustly constructed and resistant to corrosion to be long-lasting despite the rigours of seawater immersion and deck handling
- Pin locator system to ensure sieve bucket is always orientated up on retrieval to minimise puerulus losses
- Safe and convenient for commercial deck staff to service

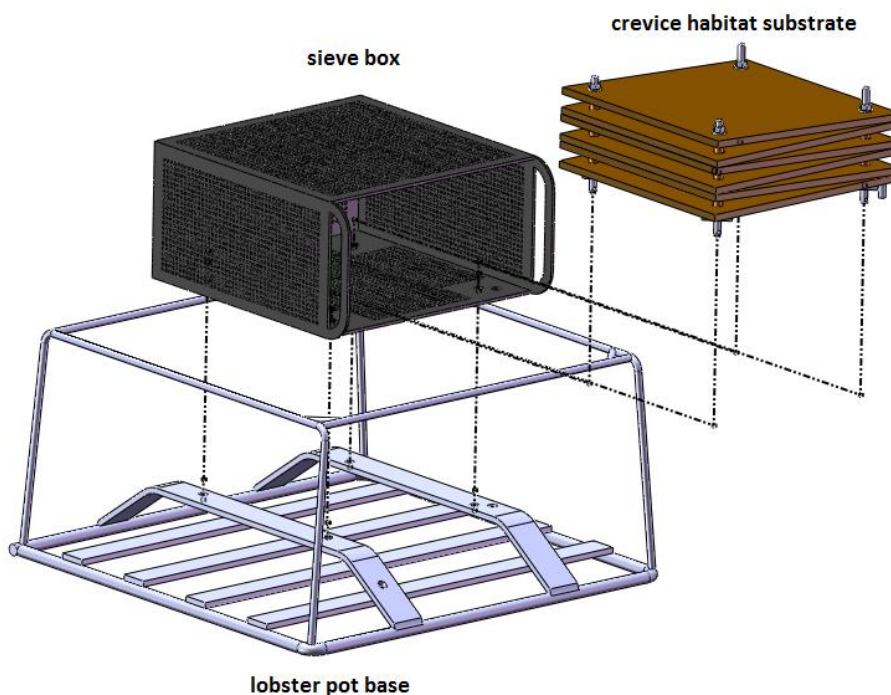

**Figure 1: Depiction of collector design and assembly**



**Figure 2: Mooring lines and floats showing use of heat shrink and hose to lessen chafing and rope unravelling.**

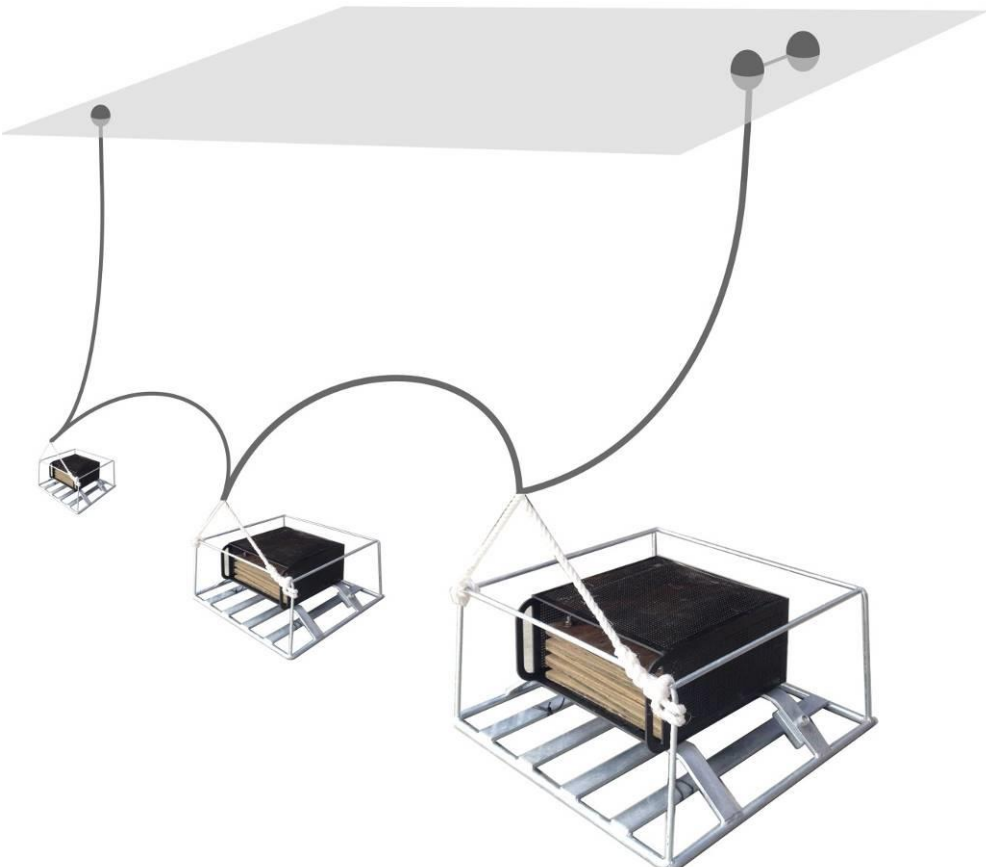

**Figure 3: Depiction of collector deployments in strings**



## Collector deployment

Collectors and mooring equipment were deployed by participating fishers in late 2015. Marine and Safety Tasmania were notified of collector coordinates for inclusion in Notice to Mariners to alert the boating public of surface buoys.

Four strings (each with 3 collectors)(Fig. 3) were deployed in each of four regions around the Tasmanian coast in an effort to provide settlement data from representative areas across the spatial extent of the commercial lobster fishery. The regions selected were King Island (NW), Eddystone Point (NE), Bruny Island (SE), and the Pyramids (SW) (Fig. 4). Within each region local fishers were consulted to select 2 sites per region on the basis of the following criteria:

- (1) Two depth categories (Medium [M] = 40 to 60m, and Deep [D] 90 to 110m) (Figs. 5, 6, 7, and 8)
- (2) On sand substrate, at least 1nm from the nearest reef habitat, and without significant reef to the seaward.
- (3) Away from known high vessel traffic or trawl fishing areas.
- (4) Not subject to strong currents

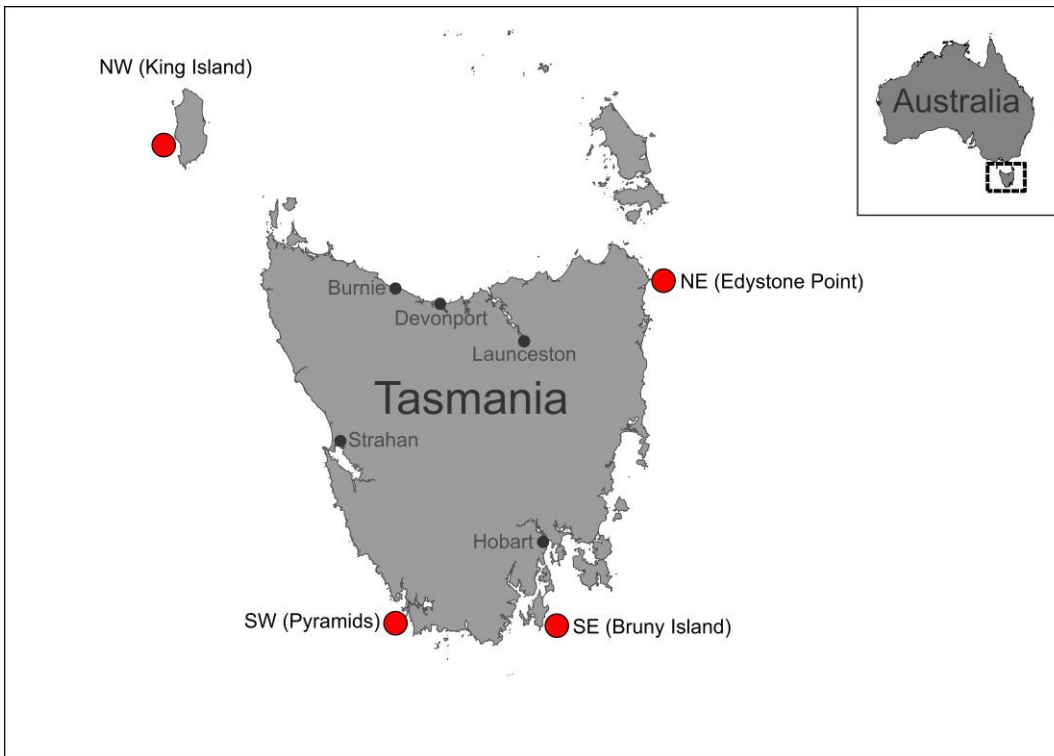

**Figure 4: Map showing puerulus monitoring sites. Phase 2 initial deployments are depicted as red circles.**

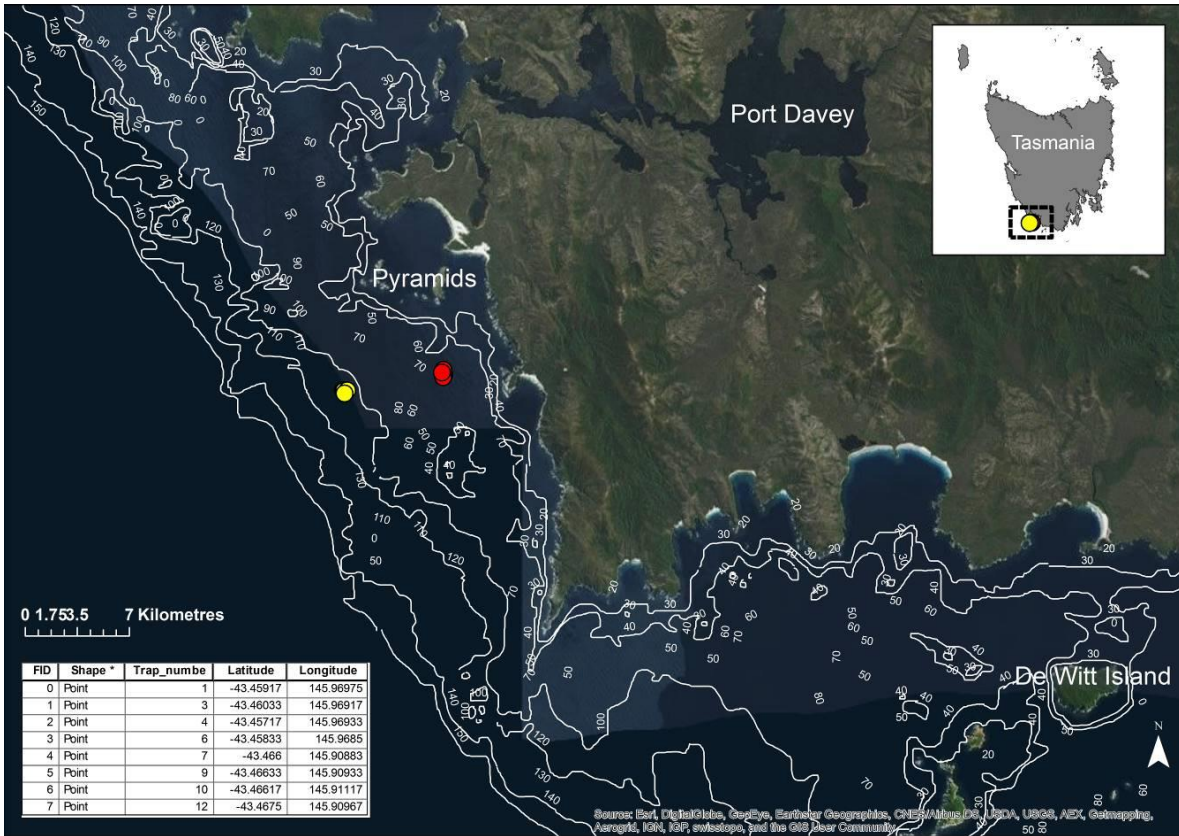

Figure 5: SW (Pyramids) collector sites. Medium depth sites (M=40-60m) are red circles and deep sites (D=90-110m) are yellow circles.

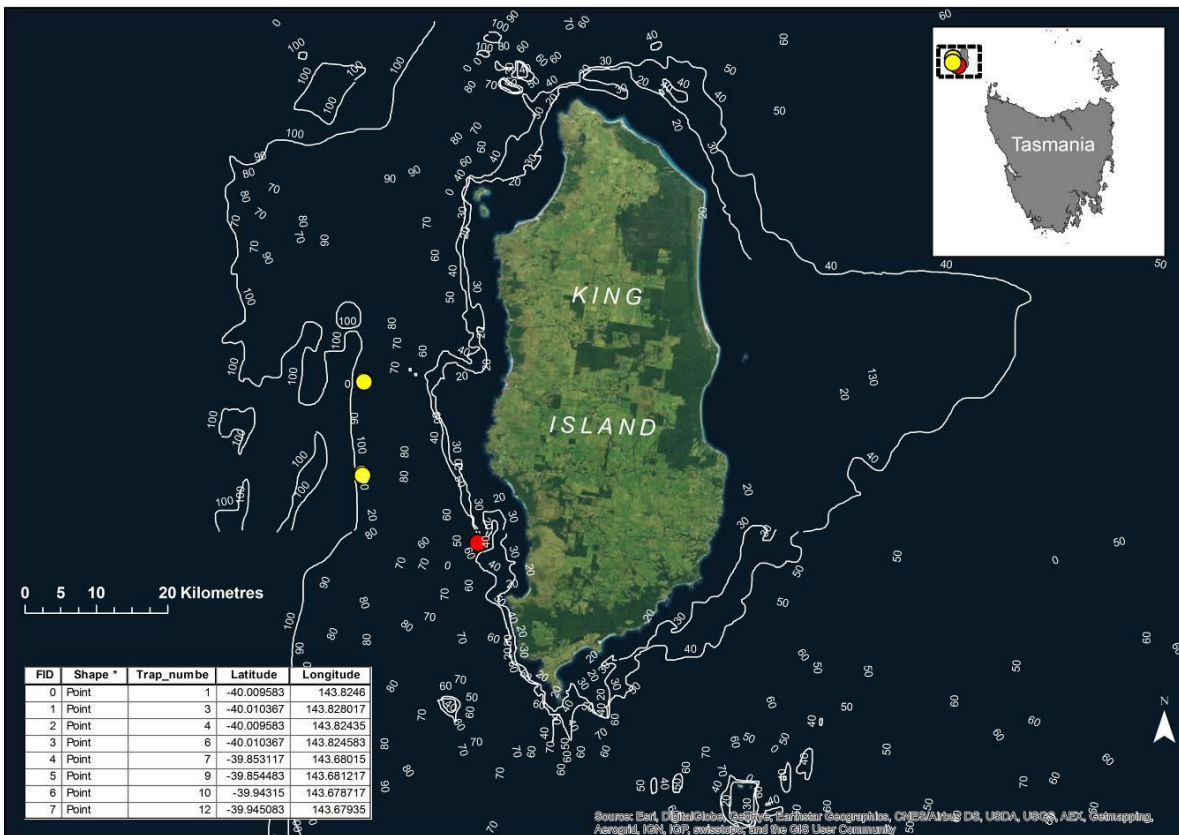

Figure 6: NW (King Island) collector sites. Medium depth sites (M=40-60m) are red circles and deep sites (D=90-110m) are yellow circles.

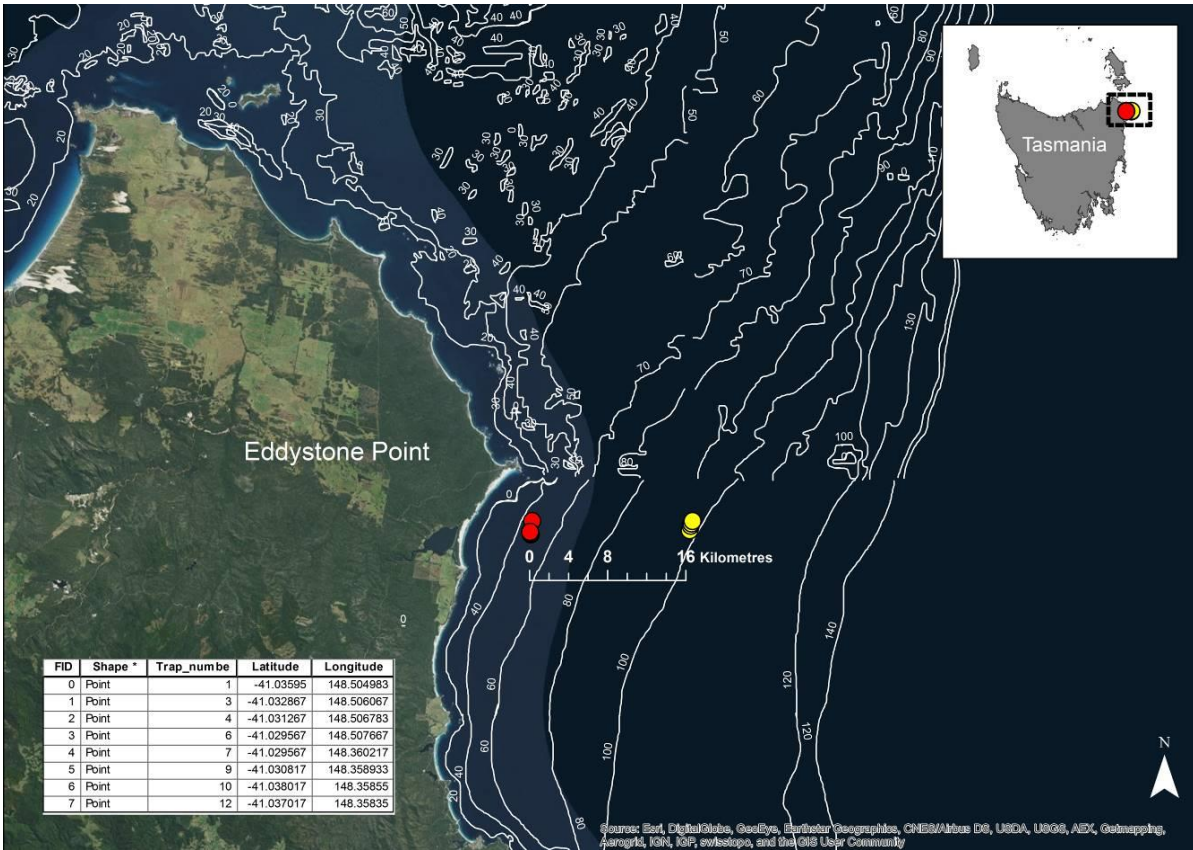

Figure 7: NE (Eddystone Point) collector sites. Medium depth sites (M=40-60m) are red circles and deep sites (D=90-110m) are yellow circles.

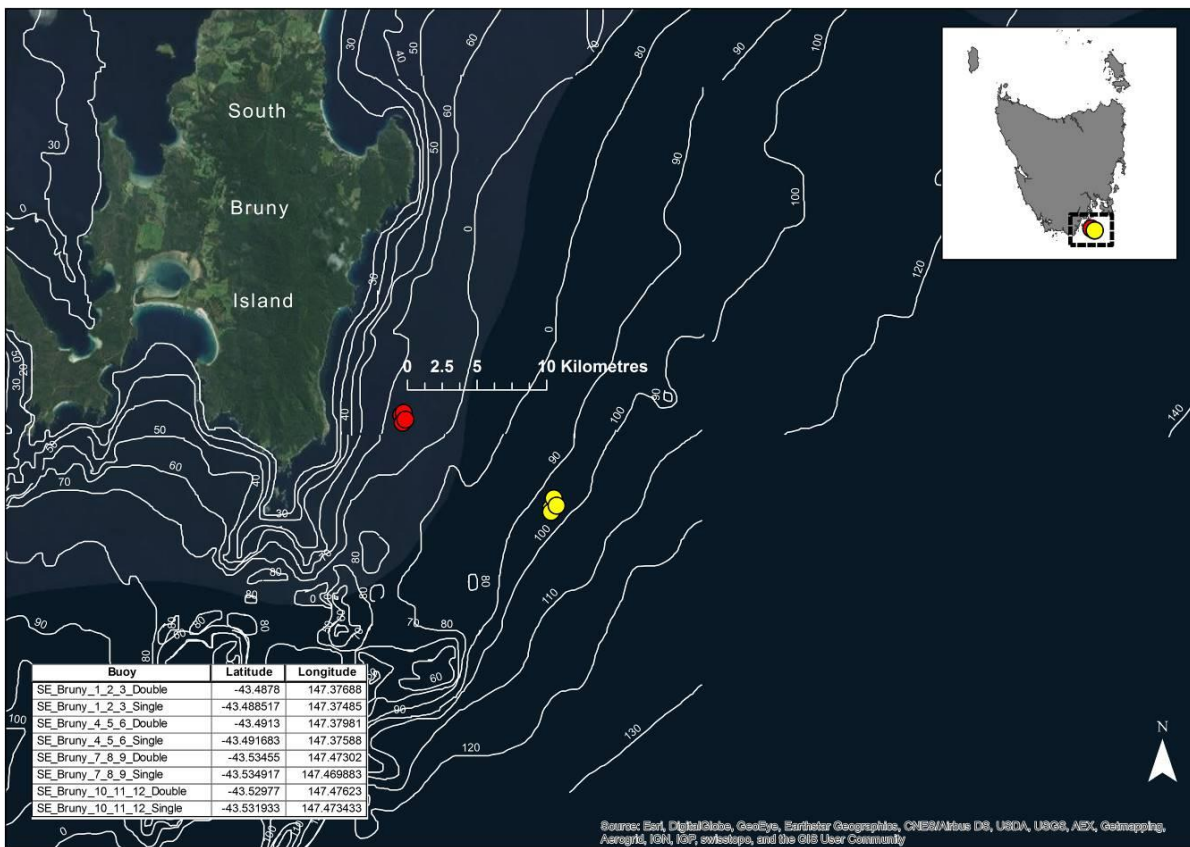

Figure 8: SE (Bruny Island) collector sites. Medium depth sites (M=40-60m) are red circles and deep sites (D=90-110m) are yellow circles.



## Collector servicing

Participating fishers (and at times IMAS staff in the SE) serviced the collectors approximately bi-monthly commencing in December 2015. Servicing entailed

- Retrieval of the collectors
- Disassembly of the collector on deck with attention to retaining any fauna in the sieve
- Removal of any fauna from the crevice substrate and sieve and preserved in 100% ethanol
- Removal of any build-up of marine fouling
- Check general condition of the collector including status of anodes and record in wheelhouse log
- Re-assemble and re-deploy recording the position of both buoyed ends of each string in wheelhouse log

More detailed servicing instructions are provided in appendix 4.

## Sample handling

Retained samples and wheelhouse logs were forwarded to IMAS staff for collation, identification of puerulus catch rates, and taxonomic analyses of retained fauna.

## Statistical Methods

Puerulus catch rates are expressed as the density of puerulus per collector by site. Generalised linear models (GLM) with a Gaussian error distribution, was used for puerulus density comparisons listed below. All GLMs were conducted using the package *MASS* in *R* (Venables and Ripley, 2003). Model fit was assessed via residual plots and in each case the dependent variable of puerulus density (number per collector) was  $\log(x + 1)$  transformed to improve model fit. Statistical significance was assessed at an alpha value  $P < 0.05$ . All comparisons are displayed graphically as boxplots where the points represent outliers, the black line in the middle represents the median, the whiskers represent the minimum and maximum values, the bottom of the box represents the first quartile, and the top of the box represents the third quartile.

## Comparisons of collector designs

The relative efficacy of the three collector designs used to monitor puerulus settlement in Tasmania (traditional diver-serviced, P1, and P2 collectors) were compared on the basis of catch rate.

### Phase 1 and phase 2 collectors

The catch rates of the two deep water collector designs were compared directly from concurrent mixed deployments of P1 and P2 across a range of depths.

### Traditional diver-serviced and Phase 1&2 deep water designs

The catch rates of the deep water collector designs were compared with catches from traditional diver-serviced collector designs from concurrent deployments in the same depth category.

## Spatial and depth trends in settlement

Catch rates from concurrent collector deployments around the Tasmanian coast were compared to investigate spatial factors structuring trends in settlement of puerulus.

## **Depth effects on puerulus settlement rates**

Catch rates from concurrent collector deployments across depth gradients were compared to investigate the relationship between depth and puerulus settlement.

## **Spatial effects on puerulus settlement rates**

Catch rates from concurrent collector deployments at various locations around the Tasmanian coast were compared to investigate spatial factors structuring settlement of puerulus.

## **Temporal trends in settlement**

Catch rate trends between seasons were compared by site to examine seasonal trends in puerulus settlement. Bimonthly catch rates were also compared within sites and between inshore traditional catches and offshore fisher-serviced catches to determine the extent to which inshore and offshore puerulus settlement trends are coupled.

## **Dissemination of design to beneficiaries**

The P2 collector design was disseminated to other precincts with commercial *Jasus edwardsii* fisheries.

### **South Australia**

Four P2 deep water collectors were delivered to the South Australian Northern Zone Rock Lobster Fishermen's Association and were deployed in the Spencer Gulf in South Australia from June 2016 to September 2017. Catches in P2 collectors were compared with catches in adjacent traditional diver-serviced puerulus collectors.

### **New Zealand**

The New Zealand Rock Lobster Industry Council Ltd (NZ RLIC) is the umbrella organization for nine regional commercial stakeholder organizations operating in each of the rock lobster management areas in New Zealand. CRAMAC 2 is the stakeholder group responsible for the management area CRA 2 in the North East of the North Island including the Bay of Plenty.

Previous efforts to establish puerulus monitoring programs using conventional moored collector arrays in the Bay of Plenty were thwarted by destructive storms and coastal resource planning complications arising from the declaration of moored collectors as marine “structures”.

This project delivered Phase 2 engineering plans (Appendix 3) to CRAMAC 2 from which a fleet of collectors were constructed and deployed in the Bay of Plenty at sites from Tairua north to Coromandel. These collectors are serviced monthly by industry vessels.

## **Cost-benefit analysis to establish cost-effective future puerulus monitoring options**

A cost-benefit analysis was conducted to compare off-shore fisher-serviced methods with traditional inshore diver serviced methods. Relative costs are presented for three deep water collector array scenarios.

- Replicate or replace inshore monitoring with offshore fisher-serviced monitoring
- Replicate or replace inshore monitoring with inshore fisher-serviced monitoring
- Complement existing inshore monitoring with fisher-serviced offshore monitoring

## Value-adding

Utilising the commercial lobster fleet to service puerulus collectors in remote exposed areas of the fishery provides opportunities for value-added data collection beyond the puerulus catch rate. This project realised two such value-added research outcomes through the deployment of temperature loggers and taxonomic analysis of retained collector catches.

### Temperature loggers

Temperature and depth loggers (Sensus, ReefNet) (Fig. 9) were opportunistically placed on collectors in both the deep and shallow depth categories in each of the four regions. Loggers recorded depth and temperature every 12 hours and were retained for downloading and renewed by fishers during routine service events.



**Figure 9: ReefNet Sensus temperature and depth logger**

### Species composition of collector catches

Retained fauna samples from collectors were transferred to the IMAS laboratory where a sub-group of samples was sorted to species, a reference collection was collated, and temporal variation in assemblages were compared with reference to site and depth using non-parametric multi-dimensional statistical techniques.

# Results

The industry-serviced collectors developed in this project were successfully deployed and serviced across a number of locations and depths in Phase 1 (P1) during the 2012/2013 puerulus settlement season and Phase 2 (P2) during the 2015/2016 and 2016/2017 settlement seasons. For the purposes of this report, the puerulus settlement season extends from November to October in the following year. Servicing entailed 98 site service events (including 17 in P1) which involved 830 individual collector services (88 in P1).

The P2 collectors deployed in the 2015/16 settlement season across two depth strata at each of 4 regions around the Tasmanian coast yielded very low catches of puerulus relative to catches in P1 and to concurrent routine inshore puerulus monitoring sites. (Table 2).

This necessitated a review of the sampling strategy to investigate the possible explanations for such low puerulus catches and to maximise the likelihood that the project delivered against its objectives. The review process was conducted in consultation with the Tasmanian lobster fisheries manager (Hillary Revill, DPIPW Tasmania) and industry (John Sansom EO Tasmanian Rock Lobster Fishermen's Association and a number of participating fishers). Factors thought responsible for the low puerulus catches fell into 3 basic categories:

- F1. Temporal variation in puerulus settlement – were more puerulus captured in phase 1 because there were more puerulus settling in the 2012/13 season?
- F2. Spatial variation in puerulus settlement – were the sites selected in phase 2 locations where puerulus are unlikely to settle?
- F3. The P2 collector design is less effective at attracting and retaining puerulus - did refinements to the phase 2 collector design affect puerulus catch rates?

If F2 and/or F3 were responsible for the low catches, a change to the experimental design was warranted to improve the potential to deliver against project objectives. If F1 alone was structuring the variation in catches, a change in the experimental design would result in the unnecessary loss of inter-seasonal temporal comparisons.

Despite, a concurrent reduction in puerulus catches at traditional inshore puerulus collection sites, it was decided that the risk of continuing to experience very low puerulus catches was too high to maintain the existing sampling strategy. Also considered were the following issues:

- In the late 1980's and early 1990's when the current shallow water longer-term monitoring sites were selected, collectors were placed in a range of sites and the best sites, based on rates of settlement, were chosen. Many of the Tasmanian sites trialled during these surveys yield virtually no catches
- While the sites in shallow water are on sand substrate, they are also relatively close to natural reefs. Because of the concern over fouling and entanglement of the ropes with reefs between collectors, the deep water sites were situated well away from natural reefs.
- The refinements of the design of the collectors may have had an impact on either collector efficiency or predator attraction e.g. increased habitat for octopus.

Consequently, the sampling strategy was changed in October 2016 at the end of the 2015/2016 settlement season. Collectors were recalled and re-deployed at sites on the Tasmanian south (S) and east (E) coasts (Fig. 10) in an attempt to improve puerulus catches and to investigate factors affecting puerulus catch rates and hence criteria for future sample site selection.

Firstly, the re-deployment entailed deployment of six P2 collectors interspersed with four P1 collectors onto the site which yielded the highest puerulus catch rates in phase 1 in the South region of the Tasmanian coast (adjacent to De Witt Island) (Fig. 10). This explicitly addressed temporal (F1), and spatial (F2) variation in

settlement, and also design factors (F3) by allowing a direct comparison of current catches with P1 catches across both collector designs.

Secondly, collectors were deployed in October 2016 on the Tasmanian east coast at Bicheno adjacent to the routine inshore puerulus monitoring sites (in Waubs Bay) (Fig. 11). This deployment consisted of four P2 interspersed with four P1 collectors in 7m of water in close proximity to the routine inshore sites; eight P2 collectors approximately 2km seaward from the inshore sites and in close proximity to the edge of an isolated reef in 28m; and eight P2 collectors approximately 4km seaward in 45m but not in close proximity to a reef system. These deployments provided direct comparisons of P1 and P2 collector designs (F3), of proximity to reef and of collector depth (F2), as well as of inshore traditional collectors against the deep water collectors.

The number of collectors deployed in each region, is summarised by season, depth, and the number of service events in Table 1. The re-deployed collectors were serviced routinely by commercial rock lobster fishers on an approximately bi-monthly basis; except for the P1 and P2 collectors deployed inshore at Bicheno which were serviced monthly by IMAS staff.

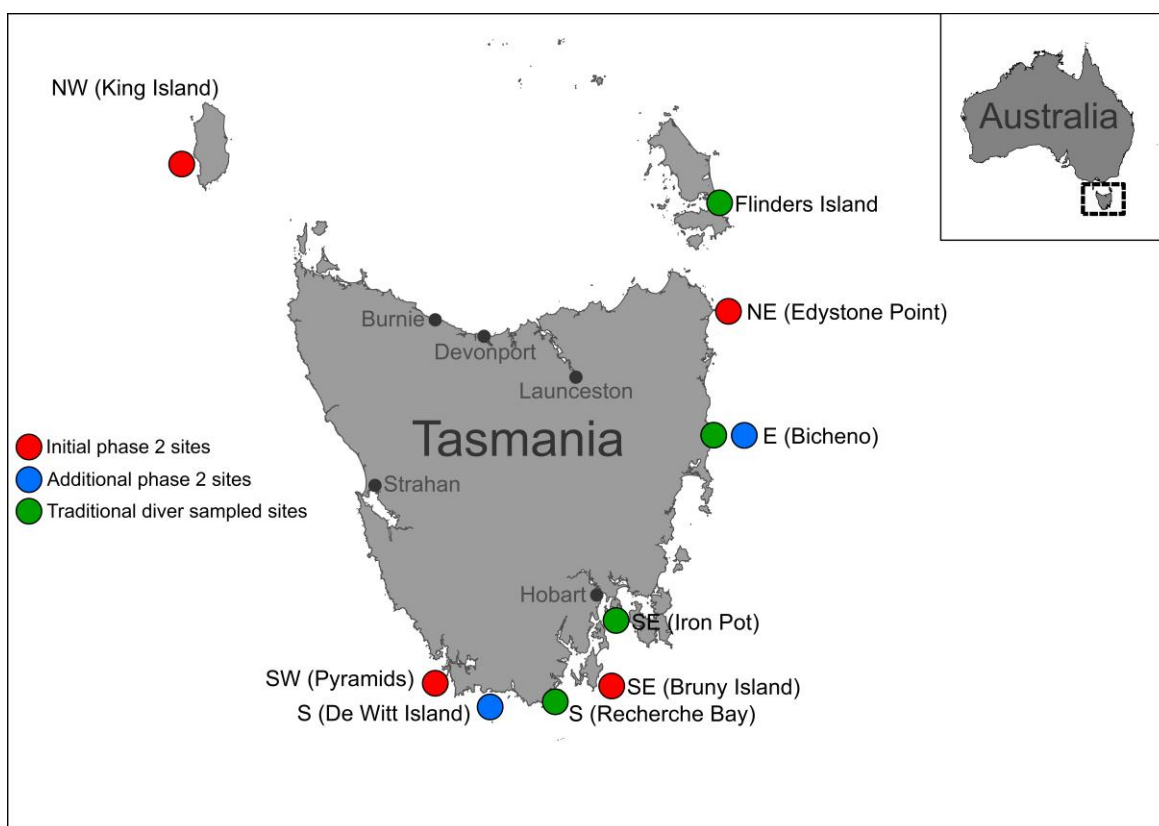

**Figure 10: Map showing puerulus monitoring sites. Phase 2 initial deployments are depicted as red circles with phase 2 additional deployments being depicted by blue circles and traditional IMAS diver serviced sites depicted as green circles.**



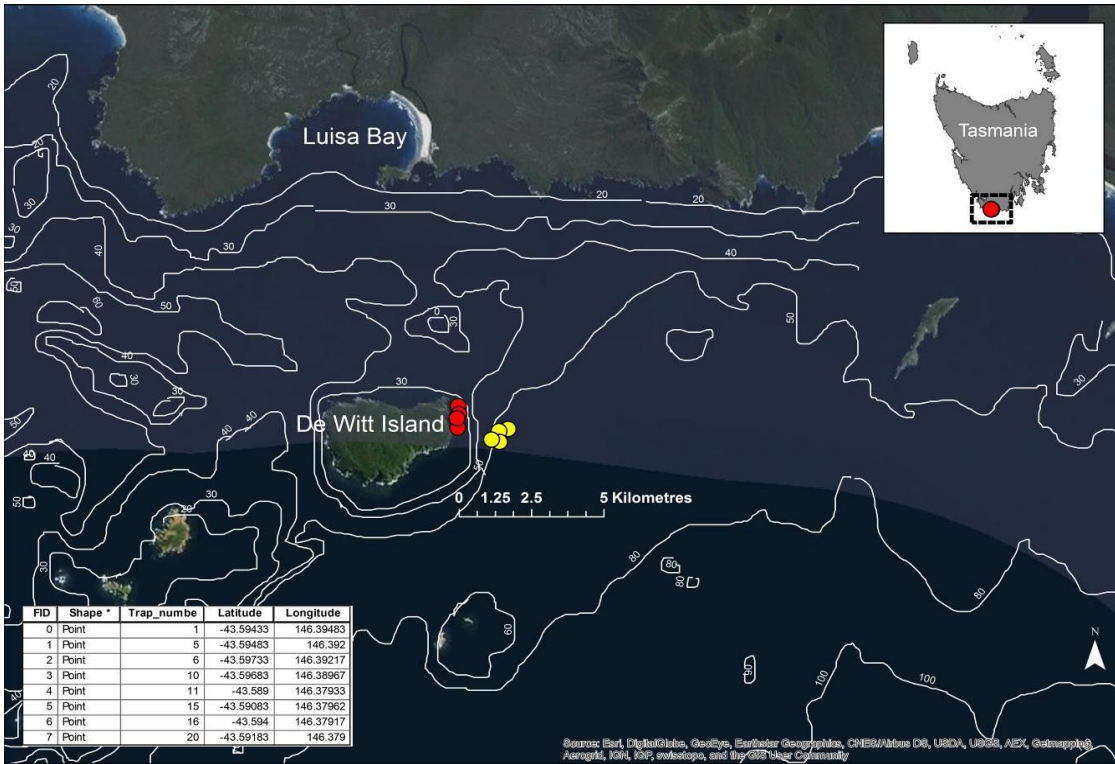

Figure 11: South (S) collector sites adjacent to De Witt Island. Medium depth sites (M=40-60m) are yellow circles and medium shallow sites (MS=25-40m) are red circles.

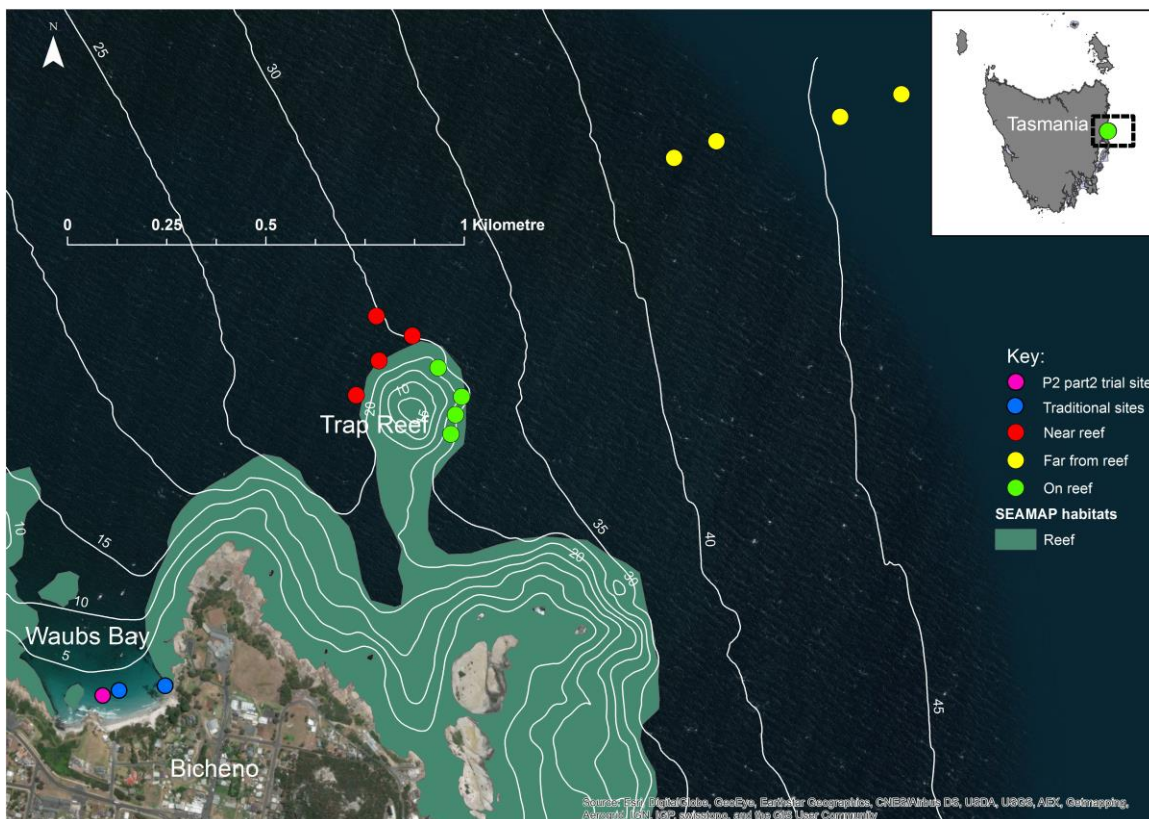

Figure 12: E (Bicheno) collector sites. Medium depth sites (M=40-60m) are yellow circles, medium-shallow sites (MS=30-40m) are red and green circles, and shallow sites (S=<10m) are pink and blue circles. Green overlay indicates reef from the IMAS surveyed habit maps.

**Table 1. Number of collectors by region and depth [SH (<10m), MS (25-40m), M (40-60m), D (90-110m)]**

<b>Region/site</b>	<b>Season</b>	<b>Depth</b>	<b>Collectors</b>	<b>Service</b>
<b>South (S)</b>	<b>2016/2017</b>	<b>MS</b>	<b>10</b>	<b>5</b>
<b>De Witt</b>	<b>2016/2017</b>	<b>M</b>	<b>10</b>	<b>5</b>
	<b>2017/2018</b>	<b>MS</b>	<b>10</b>	<b>2</b>
	<b>2017/2018</b>	<b>M</b>	<b>10</b>	<b>2</b>
<b>East (E)</b>	<b>2016/2017</b>	<b>SH</b>	<b>8</b>	<b>3</b>
<b>Bicheno</b>	<b>2016/2017</b>	<b>MS</b>	<b>12</b>	<b>5</b>
	<b>2016/2017</b>	<b>M</b>	<b>6</b>	<b>5</b>
	<b>2017/2018</b>	<b>MS</b>	<b>12</b>	<b>1</b>
	<b>2017/2018</b>	<b>M</b>	<b>6</b>	<b>1</b>
<b>Southeast (SE)</b>	<b>2015/2016</b>	<b>M</b>	<b>6</b>	<b>5</b>
<b>Bruny Is.</b>	<b>2015/2016</b>	<b>D</b>	<b>6</b>	<b>5</b>
<b>Northeast (NE)</b>	<b>2015/2016</b>	<b>M</b>	<b>6</b>	<b>7</b>
<b>Eddystone</b>	<b>2015/2016</b>	<b>D</b>	<b>6</b>	<b>7</b>
<b>Northwest (NW)</b>	<b>2015/2016</b>	<b>M</b>	<b>6</b>	<b>5</b>
<b>King Is.</b>	<b>2015/2016</b>	<b>D</b>	<b>6</b>	<b>5</b>
<b>Southwest (SW)</b>	<b>2015/2016</b>	<b>M</b>	<b>6</b>	<b>5</b>
<b>Pyramids</b>	<b>2015/2016</b>	<b>D</b>	<b>6</b>	<b>5</b>

**Table 2: Puerulus catches by season (Dty = density of puerulus/collector averaged across service events, N = number of service events, and SE = standard error) from phase one of the project (2012/2013 puerulus settlement season) and phase two (2015/16 and 2016/17 settlement seasons), including inshore traditional diver-based puerulus catches. Mean densities are listed by depth [SH (<10m), MS (25-40m), M (40-60m), D 90-110m)], region, collector type (TD = traditional inshore, P1 = phase 1, and P2 = phase 2 collector designs), and proximity to reef (Near = within 200m of significant reef habitat, Far = beyond 1km from reef, and On = on reef).**

Region	Site	Type	Reef	Depth	Mean density of puerulus											
					2012/13			2015/16			2016/17			2017/18		
					Dty	N	SE	Dty	N	SE	Dty	N	SE	Dty	N	SE
<b>South</b>	Recherche	TD	Near	SH	6.11	10	1.72	1.55	6	0.41	7.91	9	1.95	22.5	2	7.75
	DeWitt	P1	Far	M	0.78	3	0.55	-	-	-	0.80	5	0.37	4.50	2	3.25
	DeWitt	P1	Far	D	0	3	0	-	-	-	-	-	-	-	-	-
	DeWitt	P2	Far	M	-	-	-	-	-	-	0.60	5	0.19	3.83	2	3.17
	DeWitt	P2	Near	MS	-	-	-	-	-	-	0.54	5	0.19	4.69	2	2.69
<b>South West</b>	Pyramids	P1	Far	M	0.67	3	0.17	-	-	-	-	-	-	-	-	-
	Pyramids	P1	Far	D	0.06	3	0.06	-	-	-	-	-	-	-	-	-
	Pyramids	P2	Far	M	-	-	-	0.03	5	0.03	-	-	-	-	-	-
	Pyramids	P2	Far	D	-	-	-	0	5	0	-	-	-	-	-	-
<b>East</b>	Bicheno	TD	Near	SH	4.72	18	0.76	1.74	10	0.42	6.96	16	1.09	4.13	2	1.38
	Bicheno	P1	Near	SH	16.7	5	5.23	-	-	-	6.42	3	3.04	-	-	-
	Bicheno	P2	Near	SH	-	-	-	-	-	-	2.42	3	1.42	-	-	-
	Bicheno	P2	Near	MS	-	-	-	-	-	-	0.48	6	0.23	0.13	1	-
	Bicheno	P2	On	MS	-	-	-	-	-	-	0.33	5	0.12	0.25	1	-
	Bicheno	P2	Far	M	-	-	-	-	-	-	0.33	5	0.15	0	1	-
<b>North East</b>	Eddystone	P2	Far	M	-	-	-	0.01	7	0.01	-	-	-	-	-	-
<b>North West</b>	Eddystone	P2	Far	D	-	-	-	0	7	0	-	-	-	-	-	-
<b>North West</b>	King Is.	P2	Far	M	-	-	-	0.12	5	0.08	-	-	-	-	-	-
<b>South East</b>	King Is.	P2	Far	D	-	-	-	0.02	5	0.02	-	-	-	-	-	-
<b>Southeast</b>	Iron Pot	TD	Near	SH	1.24	11	0.21	1.16	6	0.33	3.67	9	1.15	1.96	3	1.05
	Bruny Is.	P2	Far	M	-	-	-	0	5	0	-	-	-	-	-	-
	Bruny Is.	P2	Far	D	-	-	-	0	5	0	-	-	-	-	-	-

## Comparisons of collector designs

### Phase 1 and phase 2 collectors

A comparison of the catch rates of P1 and P2 collectors at sites where they are directly comparable (Bicheno shallow and DeWitt medium deep) yielded no significant differences between the two collector designs, between regions, or the interaction of the two (Fig 13, Table 3). This confirms that the poor puerulus catches in the 2015/2016 season were not due to reduced efficacy of the P2 design and allowed P1 and P2 collector types to be pooled for spatial and temporal comparisons of puerulus density.

**Table 3. Parameter estimates of the generalised linear model (GLM) relating puerulus density to region and trap type. Note that the response variable is  $\log(x + 1)$  transformed. The “intercept” parameter corresponds to the predicted puerulus density (number/collector) in the East with P1 trap type. A colon indicates an interaction. P1 = Phase 1, P2 = Phase 2. Note that P-values in bold are significant.**

	Estimate	SE	<i>t</i> -value	<i>P</i> -value
Intercept	1.76	0.44	3.99	< <b>0.001</b>
Region (South)	-0.97	0.52	-1.86	0.08
Trap type (P2)	-0.69	0.62	-1.11	0.28
Region (South):Trap type (P2)	0.79	0.73	1.09	0.29

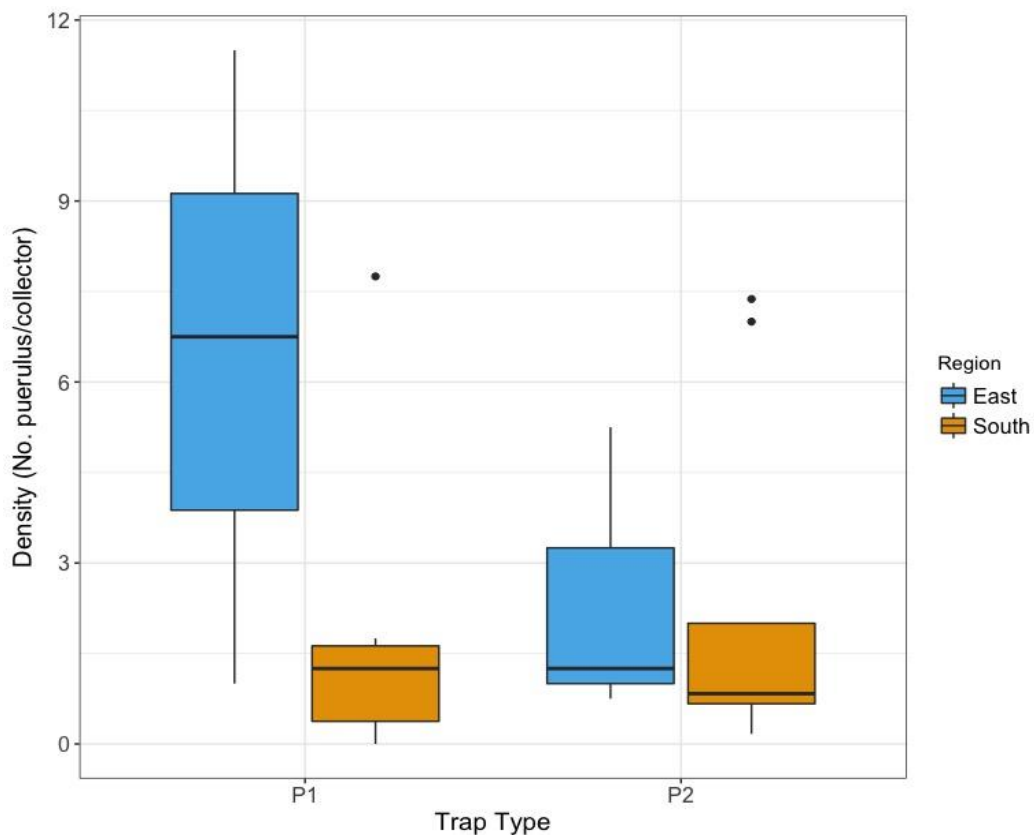

**Figure 13: Comparison of mean catch rates of puerulus from the collector design used in Phase 1 of this project and rates from the refined design used in phase 2.**

## Traditional diver-serviced and Phase 1&2 deep water designs

Phase 1 and phase 2 collectors, and the 2012/2013 and 2016/2017 settlement seasons, were pooled for a comparison of puerulus catch rates at the Bicheno shallow site between diver-serviced traditional collectors and deep water collector designs. Deep water collectors showed a higher mean puerulus density than traditional collectors, although the difference was not statistically significant due to high variance in the deep water collector densities (Fig. 14; Tables 4). The high variance was due to two occasions of uncharacteristically poor performance by the deep water designs as a result of high rates of sedimentation during adverse swell conditions. Traditional collector designs were not susceptible to sedimentation under these conditions due to their pole mounted design providing a higher clearance above the seafloor.

**Table 4. Parameter estimates of the generalised linear model (GLM) relating puerulus density to collector type. Note that the response variable is log ( $x + 1$ ) transformed. The “intercept” parameter corresponds to the predicted puerulus density (number/collector) from the deep water collector. Note that *P*-values in bold are significant.**

	Estimate	SE	<i>t</i> -value	<i>P</i> -value
Intercept	1.97	0.23	8.67	<b>&lt;0.001</b>
Collector type (Diver serviced)	-0.25	0.26	-0.94	0.35

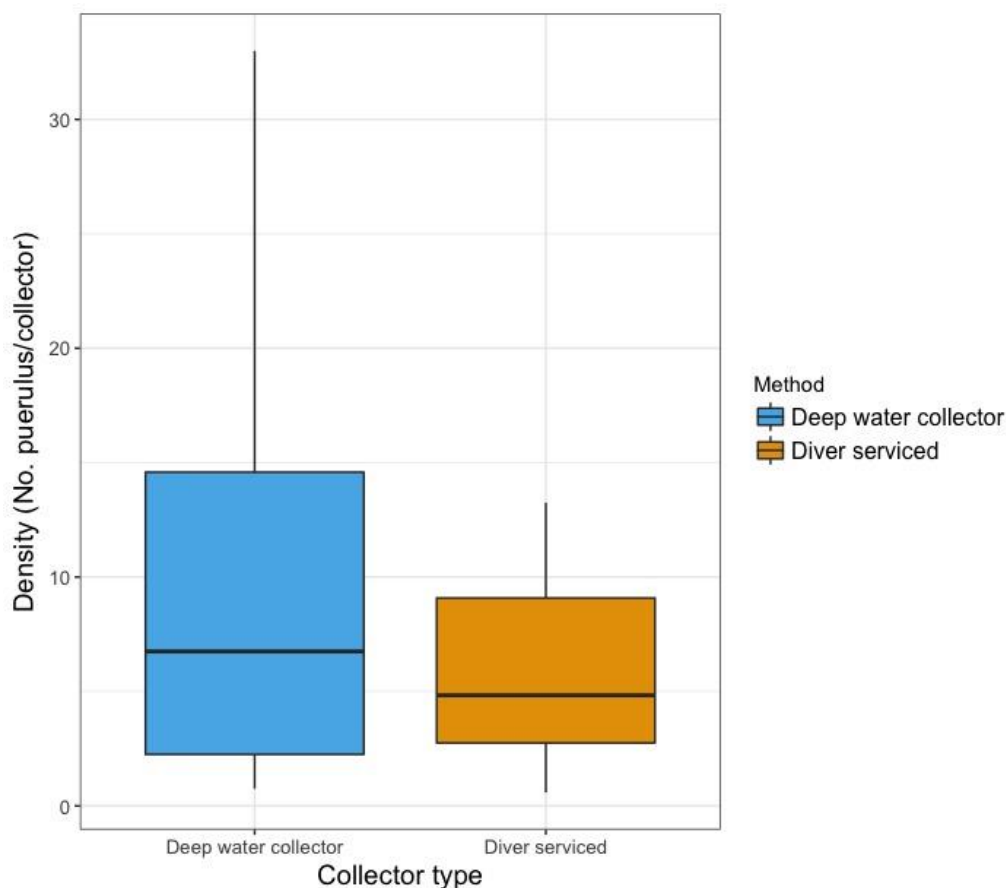

**Figure 14: Comparison of mean catch rates of puerulus between deep water collectors and traditional diver-serviced collectors concurrently deployed at adjacent inshore shallow sites (<10m depth).**

## Spatial and depth trends in settlement

Due to the very low settlement rates in the 2015/2016 settlement season and the subsequent change to the sampling strategy in October 2016, spatial comparisons were generally restricted to the 2012/2013, 2016/2017, and/or the 2017/2018 seasons and to the South and East coast regions where concurrent sampling yielded catches sufficient for statistical analysis.

### Depth effects on puerulus settlement rates

The influence of depth on puerulus settlement rates was compared using catch rates from the East and the South coast regions over the 2013/2015 and 2016/2017 settlement seasons which hosted concurrent data from shallow (SH), medium shallow (MS) and medium deep (M) depth strata. There was a dramatic depth effect with significantly higher catches in shallow water (Fig. 15; Table 5).

**Table 5. Parameter estimates of the generalised linear model (GLM) relating puerulus density to region and depth. Note that the response variable is  $\log(x + 1)$  transformed. The “intercept” parameter corresponds to the predicted puerulus density in the East at the M depth category. A colon indicates an interaction. Depth categories are: M = 40-60 m, MS = 25-40 m, SH = <10 m. Note that *P*-values in bold are significant.**

	Estimate	SE	<i>t</i> -value	<i>P</i> -value
Intercept	0.26	0.30	0.86	0.39
Region(South)	0.42	0.35	1.22	0.26
Depth(MS)	0.04	0.37	0.12	0.91
Depth(SH)	1.58	0.32	4.92	<b>&lt;0.001</b>
Region(South):Depth(MS)	-0.02	0.48	0.04	0.97
Region(South):Depth(SH)	-0.29	0.39	-0.75	0.46

The deep depth strata was not included in this comparison because no deep site was sampled from the East coast region. A second analysis comparing catches by depth (M and D) from the South and Southwest Regions in the 2012/2013 season yielded significantly lower catch rates in the deep depth strata (Fig. 16; Table 6). This is understandable given catch rates for the deep category are very low across the entire project sampling (2 puerulus encountered from 28 site service events involving 300 collector events).

**Table 6. Parameter estimates of the generalised linear model (GLM) relating puerulus density to depth in the south and southwest combined. Note that the response variable is  $\log(x + 1)$  transformed. The “intercept” parameter corresponds to the predicted puerulus density (number/collector) at D depth. Depth categories are: M = 40-60 m, D = 90-110m. Note that *P*-values in bold are significant.**

	Estimate	SE	<i>t</i> -value	<i>P</i> -value
Intercept	0.03	0.10	0.25	0.80
Depth (M)	0.47	0.15	3.19	<b>0.01</b>

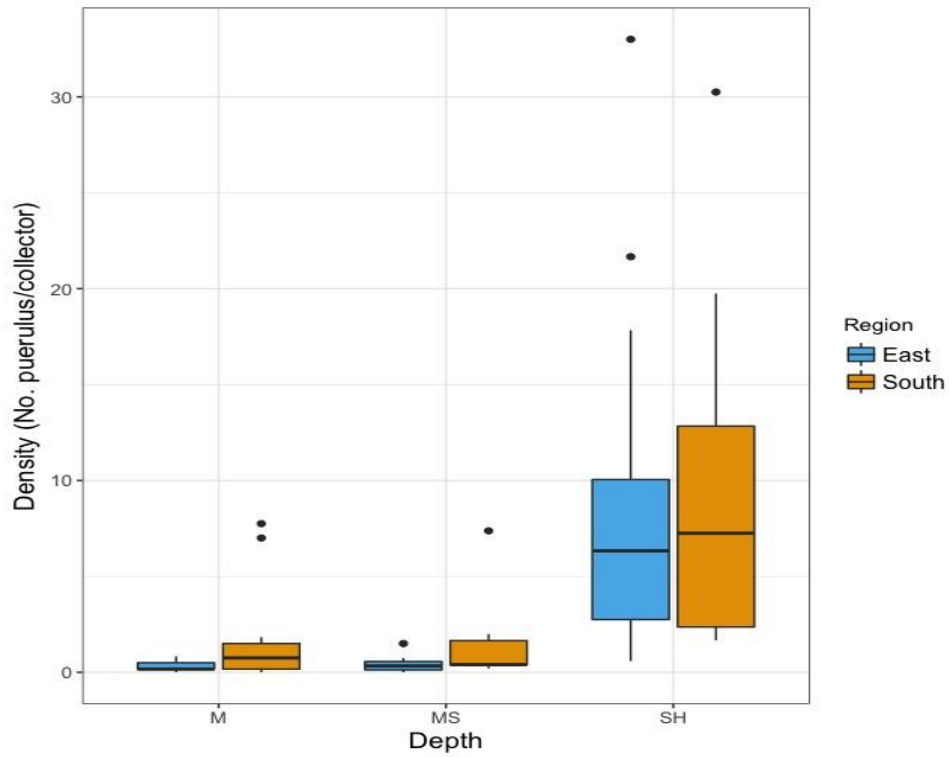

Figure 15: Comparison of mean catch rates of puerulus by depth strata at the East and South coast regions.

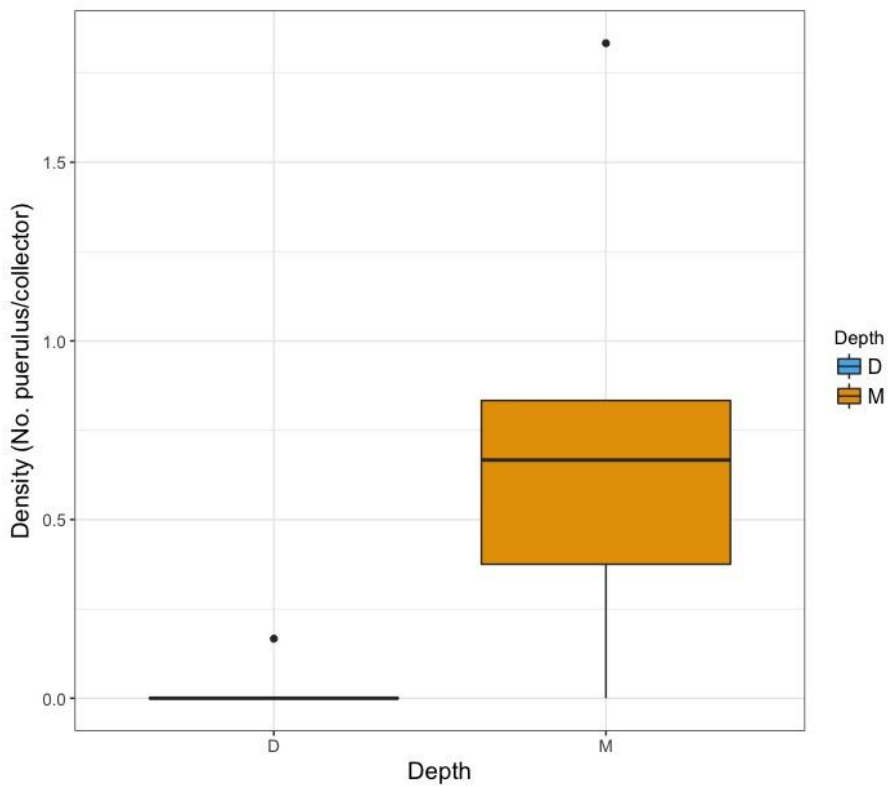

Figure 16: Comparison of mean catch rates of puerulus by depth strata at the Southwest and South coast regions in the medium and deep depth strata.

## Spatial effects on puerulus settlement rates

Differences in settlement by region were examined in catches from the 2016/2017 and 2017/2018 settlement season when concurrent sampling was conducted on the East coast and South coast regions. As depth exerts a strong influence on catches, only depth categories represented in both regions were included in the analysis (MS and M; SH and D were excluded). The south coast provided significantly higher puerulus catch rates than the east coast (Fig. 17; Table 7).

**Table 7. Parameter estimates of the generalised linear model (GLM) relating puerulus density to region. Note that the response variable is  $\log(x + 1)$  transformed. The “intercept” parameter corresponds to the predicted puerulus density (number/collector) in the east. Note that *P*-values in bold are significant.**

	Estimate	SE	<i>t</i> -value	<i>P</i> -value
Intercept	0.27	0.12	2.27	<b>0.03</b>
Region (South)	0.47	0.16	2.93	<b>0.01</b>

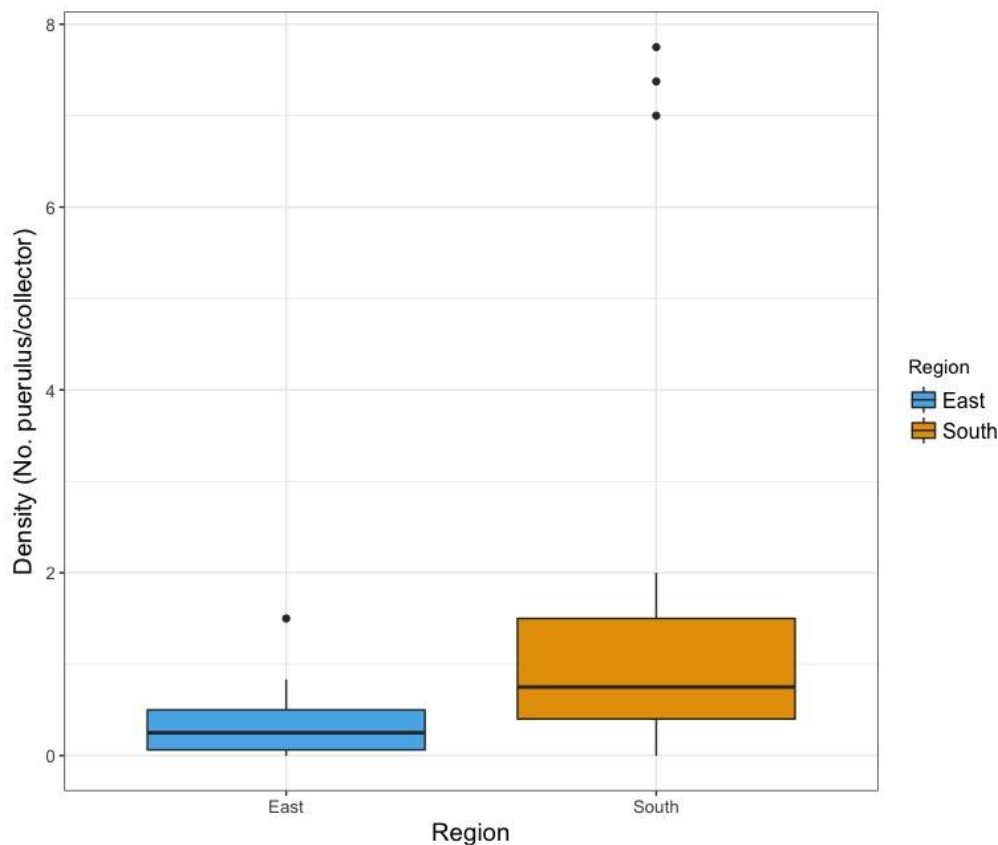

**Figure 17: Comparison of mean catch rates of puerulus collectors deployed on the South coast and the East coasts of Tasmania.**

Differences in settlement on the basis of proximity to significant rocky reef habitat was examined in response to very low catches in the 2015/2016 settlement season to inform future site selection. Puerulus catches in medium depth strata were compared in the East and South coast regions on the basis of their proximity to reef (*near* = within 200m, *far* = further than 1km, and *on* = deployed onto reef habitat). As depth exerts a strong influence on catches, only depth categories represented in both regions were included in the analysis (MS and M; SH and D were excluded). Although collectors sited *far* from reef displayed higher mean catch rates than *near* or *on*, these difference were not significantly different (Fig. 18; Table 8).



**Table 8. Parameter estimates of the generalised linear model (GLM) relating puerulus density to proximity to reef habitat. Note that the response variable is  $\log(x + 1)$  transformed. The “intercept” parameter corresponds to the predicted puerulus density (number/collector) far from reef habitat. Note that *P*-values in bold are significant.**

	Estimate	SE	<i>t</i> -value	<i>P</i> -value
Intercept	0.57	0.12	4.62	<b>&lt;0.001</b>
Proximity (Near)	-0.05	0.20	-0.26	0.80
Proximity (On)	-0.32	0.26	-1.21	0.24

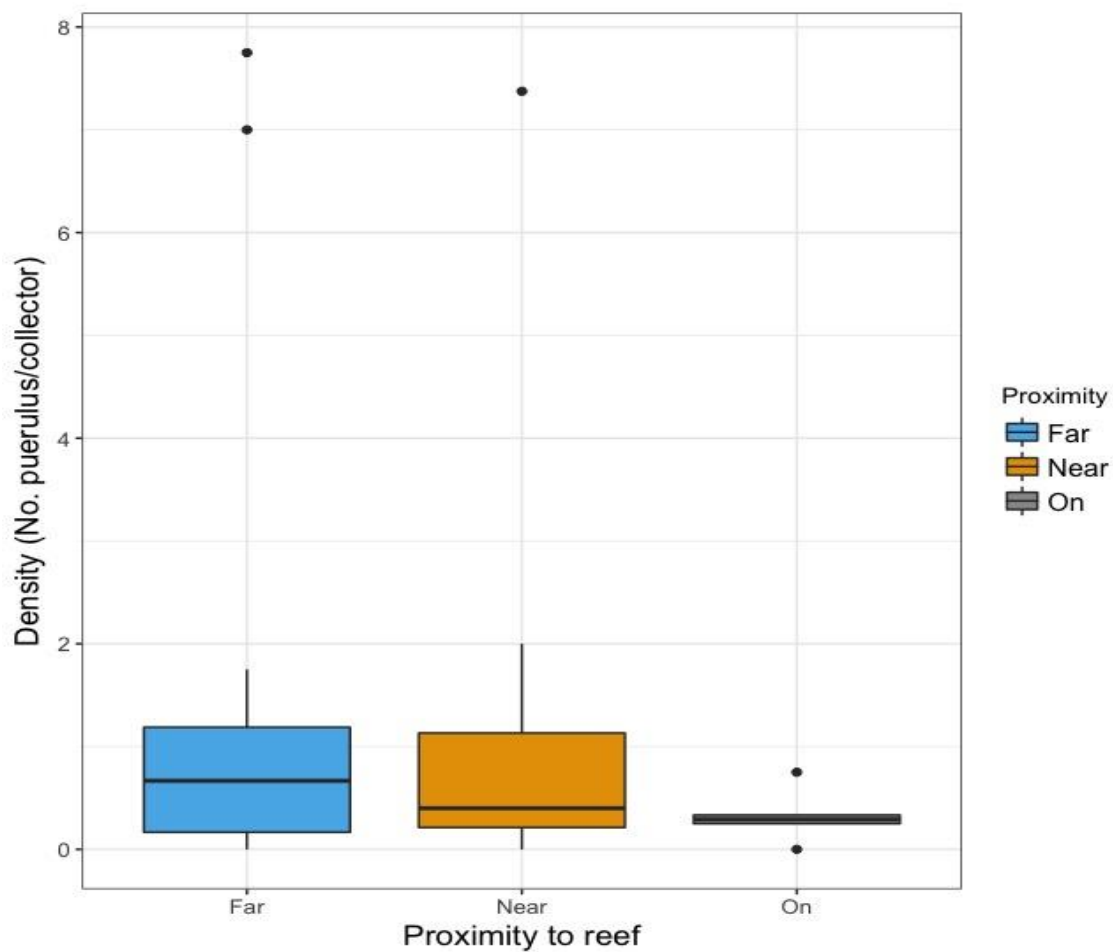

**Figure 18: Comparison of mean catch rates of puerulus between deep-water collectors positioned on, near (within 200m), or far (beyond 1000m) from rocky reef habitats.**

## Temporal trends in settlement

Differences in settlement by season were examined by comparing catch rates from the 2012/2013, 2016/2017, and 2017/2018 seasons in the South coast region in the medium depth strata; and between the 2012/2013 and 2015/2016 seasons in the Southwest coast region in both the medium and deep depth strata. The 2017/2018 season had significantly higher settlement rates than 2012/2013 or 2016/2017, but there were no significant differences between the 2012/2013 and the 2016/2017 seasons on the south coast (Fig. 19; Table 9).

**Table 9. Parameter estimates of the generalised linear model (GLM) relating puerulus density to season at DeWitt. Note that the response variable is  $\log(x + 1)$  transformed. The “intercept” parameter corresponds to the predicted puerulus density (number/collector) in 2012/2013. Note that *P*-values in bold are significant.**

	Estimate	SE	<i>t</i> -value	<i>P</i> -value
Intercept	0.48	0.28	1.74	0.09
Season (2016/2017)	-0.03	0.30	-0.12	0.91
Season (2017/2018)	0.98	0.34	2.90	<b>0.01</b>

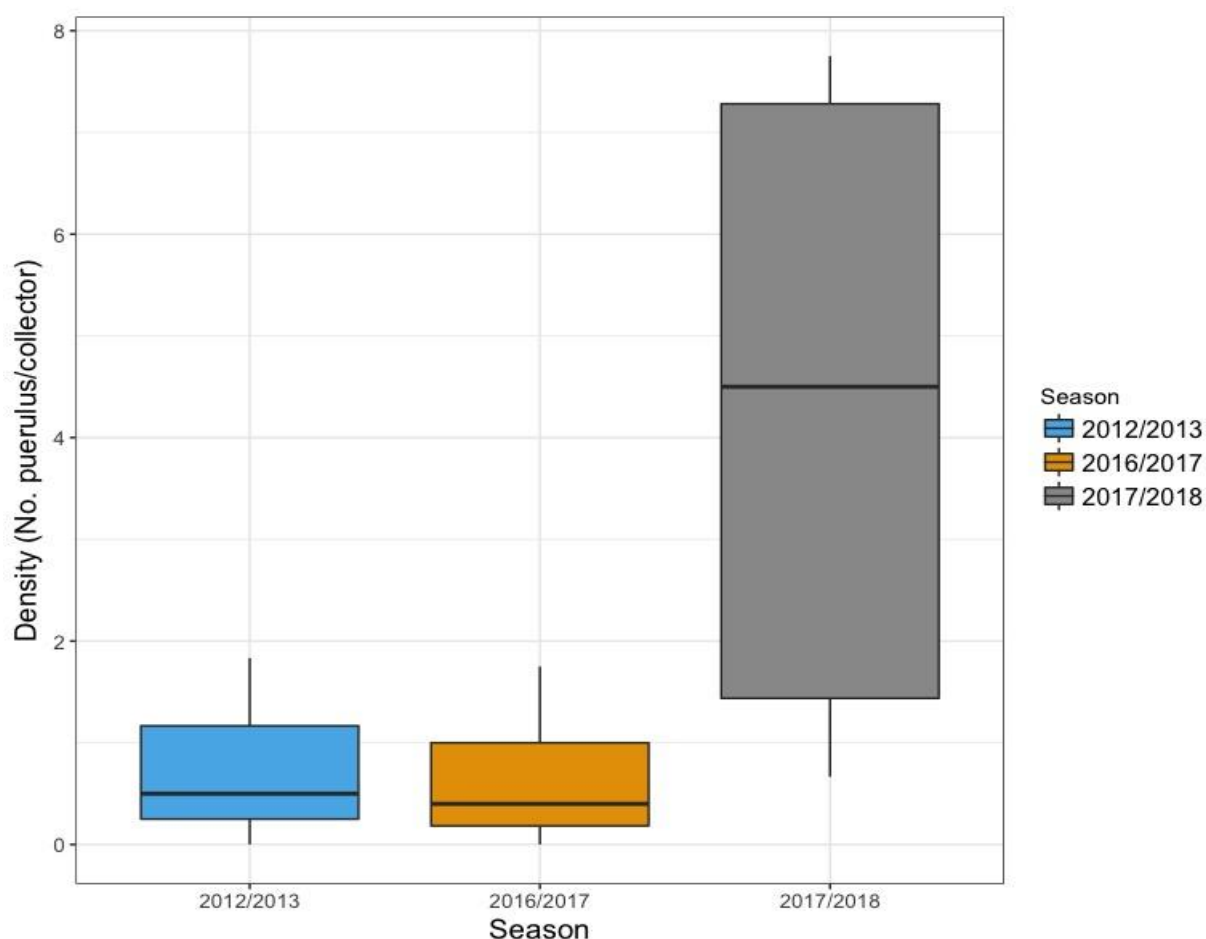
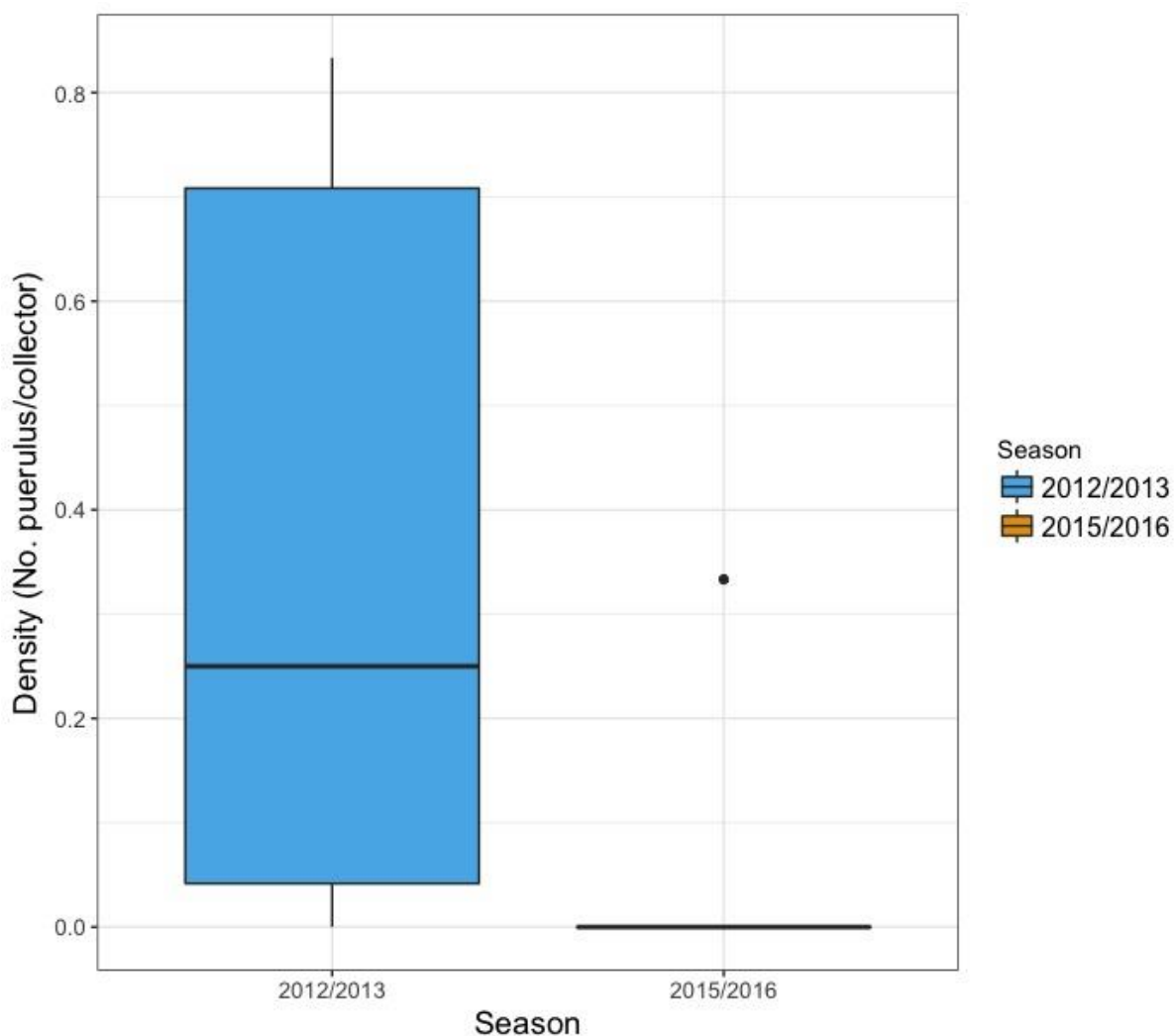

**Figure 19: Comparison of mean seasonal catch rates of puerulus between deep-water collectors on the South Coast of Tasmania**

However the fall in catch rates on the Southwest coast between the 2012/2013 and 2015/2016 settlement seasons was highly significant (Fig. 20; Table 10).

**Table 10. Parameter estimates of the generalised linear model (GLM) relating puerulus density to season in the Southwest. Note that the response variable is  $\log(x + 1)$  transformed. The “intercept” parameter corresponds to the predicted puerulus density (number/collector) in 2012/2013. Note that *P*-values in bold are significant.**

	Estimate	SE	<i>t</i> -value	<i>P</i> -value
Intercept	0.28	0.07	3.73	<b>&lt;0.01</b>
Season (2015/2016)	-0.25	0.09	-2.64	<b>0.02</b>



**Figure 20: Seasonal puerulus catch rates (puerulus per collector) on the south west coast of Tasmania.**

## Temporal depth trends in settlement

Similarities in temporal trends in settlement by depth were examined by comparing bimonthly catch rates from the 2012/2013, 2015/2016, and 2016/2017 seasons between deep water collector sites and shallow sites. The South and Southwest sites were pooled to provide settlement results for all 3 seasons and the South region inshore site at Recherche Bay was used for the shallow site in the comparison. The purpose of this comparison is to test whether inshore collectors could be replaced by deep water collector arrays to monitor trends in settlement. Consequently, Deep depth category sites, which are unsuitable for settlement monitoring due to universally very low catch rates (see depth comparison above), were not included in this comparison.

The correlation of bimonthly catch rates from South/Southwest deep water collectors and inshore traditional collectors was significant (Fig. 21A; and Table 11 All data). This shows that catches offshore reflect inshore catches over time, but at around one fifth of the catch rate (slope 0.21). However, one exceptionally high catch in January 2018 was more than 5 times the catch rate of any other period and more than the catches from every other period combined. As this single catch exerts a very high degree of influence over the correlation, offshore and inshore catch rates were also compared excluding the catch from January 2018. The comparison was also significant (Fig. 21B; Table 11) and also shows that catches offshore reflect inshore catches over time, but at around one tenth of the catch rate (slope 0.09).

**Table 11. Parameter estimates of the linear regression relating puerulus density to depth on the South/Southwest Tasmanian coast. Parameters are also reported for the same analysis with an outlying service event excluded from the analysis (March 2017). Note that *P*-values in bold are significant.**

Condition		Estimate	SE	<i>t</i> -value	<i>P</i> -value	<i>R</i> <sup>2</sup>
All data	Intercept	-0.6	0.34	-1.76	0.11	
	Inshore	0.21	0.03	6.9	<b>&lt;0.001</b>	0.81
Excluding January 2018	Intercept	-0.01	0.11	-0.11	0.91	
	Inshore	0.09	0.02	5.6	<b>&lt;0.001</b>	0.76

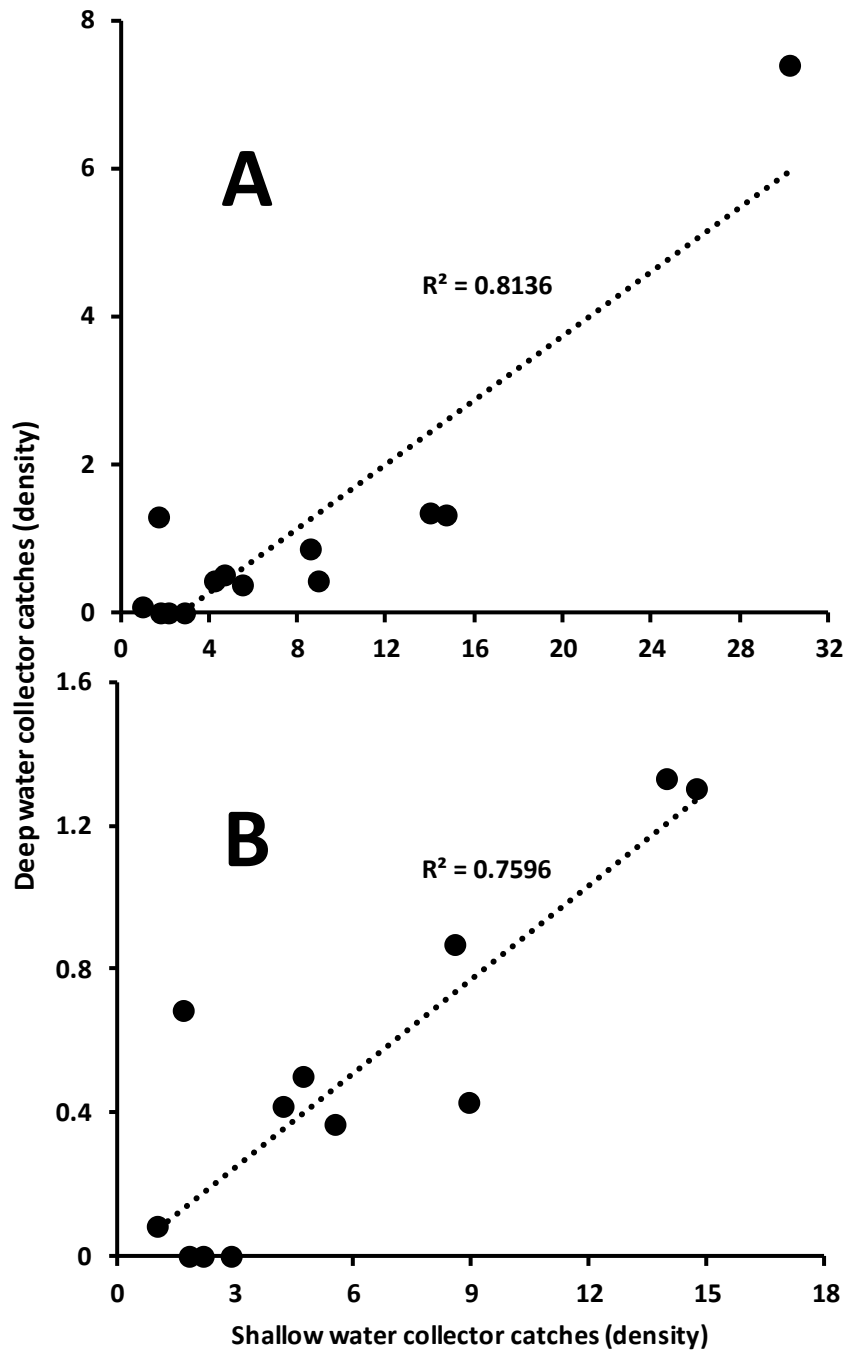

**Figure 21: Plot A shows the correlation of catch densities (puerulus/collector) for bimonthly settlement on deep water collectors (y-axis) and traditional inshore collectors (x-axis). Plot B shows the correlation of catch densities (puerulus/collector) for bimonthly settlement on deep water collectors (y-axis) and traditional inshore collectors (x-axis) excluding the catches in January 2018. Trend lines and  $R^2$  are linear regression.**

The ability of offshore collectors to provide equivalent indications of seasonal fluctuations in puerulus settlement to inshore collectors was further investigated through a comparison of seasonal percentage relative standard errors (RSE) to assess whether these methods have a similar power to detect seasonal variability in recruitment. For this comparison, the southern sites (Recherche and DeWitt) were compared as they were the only adjacent inshore/offshore sites which have been concurrently monitored across more than one season. The offshore and inshore sites display a similar RSE for the 2016/17 and 2017/18 seasons, however the inshore site showed higher variability relative to the offshore site in the 2012/13 season (Fig. 22). Therefore, although actual catch density of puerulus varied between offshore and inshore, the

consistency (similar or lower RSE) of the offshore collectors indicate that similar conclusions in temporal settlement can be made with the number of collectors deployed during this project.

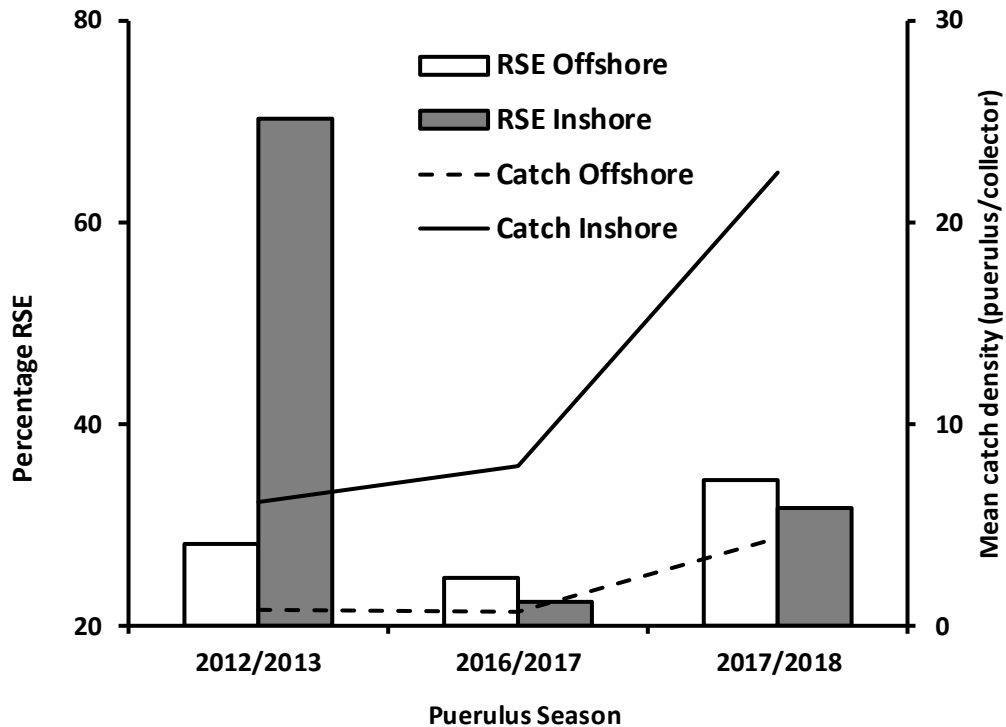

**Figure 22: Percentage relative standard errors (bars) of mean inshore and offshore puerulus catch rates (lines) by puerulus season.**

The high catch rate at both inshore and offshore sites in southern Tasmania in January 2018 also offered the opportunity for comparison of the relative retention rates of settled puerulus between inshore and offshore collectors. The mean proportion of fresh settlers (unpigmented puerulus) to retained settlers (pigmented puerulus) between collectors serviced in January 2018 inshore at Recherche Bay (mean = 0.46, N = 12, SE = 0.03) and offshore (DeWitt mean = 0.51, N = 20, SE = 0.09), were not significantly different ( $t_{\text{stat}} = 0.53$ , P = 0.6).

## Dissemination of design to beneficiaries

### South Australia

Differences in settlement were examined in South Australia between the traditional diver-serviced collectors and the deep water collector at Taylors Island and McClaren Point. Settlement did not significantly differ between sites, collector types or the interaction of the two (Fig. 23, Table 12).

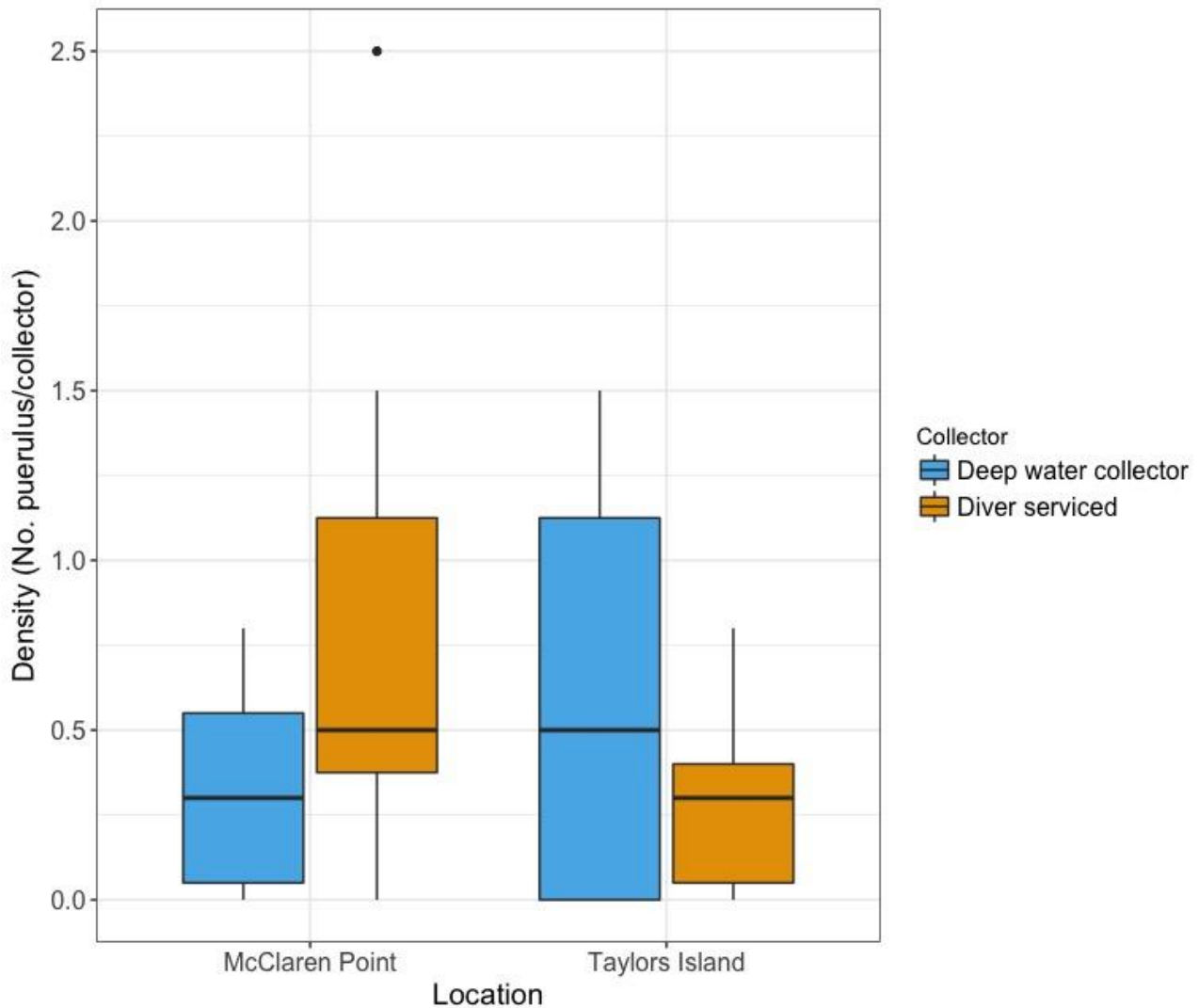

Figure 23: Comparison of mean catch rates of puerulus between deep water collectors and traditional diver-serviced collectors at McClaren Point and Taylors Island in South Australia.

**Table 12: Parameter estimates of the generalised linear model (GLM) relating puerulus density to location and collector type in South Australia. Note that the response variable is  $\log(x + 1)$  transformed. The “intercept” parameter corresponds to the predicted puerulus density (number/collector) at McClaren Point with the deep water collector. A colon indicates an interaction. Note that P-values in bold are significant.**

	Estimate	SE	<i>t</i> -value	<i>P</i> -value
Intercept	0.26	0.14	1.83	0.08
Site (Taylors Island)	0.15	0.19	0.81	0.42
Collector (Diver serviced)	0.25	0.19	1.30	0.20
Site (Taylors Island):Collector (Diver serviced)	-0.42	0.27	-1.58	0.13

**Table 13: Puerulus catches from deployments in the South Australian northern lobster fishing zone of deep water puerulus collectors (provided by this project) and from traditional diver-serviced inshore collectors.**

Site	Collector type	Date	Number of collectors	Number of puerulus	Density
Taylors Island	Tas deep water collectors	14/06/2016	2	0	0
		14/07/2016	2	0	0
		22/08/2016	2	1	0.5
		22/09/2016	2	2	1
		09/11/2016	2	3	1.5
		27/06/2017	2	0	0
		14/08/2017	2	1	0.5
		08/09/2017	2	3	1.5
	Diver-serviced	13/05/2016	5	0	0
		14/06/2016	5	0	0
		14/07/2016	5	1	0.2
		23/08/2016	5	2	0.4
		22/09/2016	5	2	0.4
		09/11/2016	5	4	0.8
McClaren Point	Diver-serviced	13/05/2016	5	0	0
		14/06/2016	5	0	0
		14/07/2016	5	2	0.4
		23/08/2016	5	4	0.8
		22/09/2016	5	1	0.2
		27/10/2016	5	3	0.6
		14/06/2016	2	0	0
	Tas deep water collectors	14/07/2016	2	1	0.5
		22/08/2016	2	1	0.5
		22/09/2016	2	1	0.5
		27/10/2016	2	2	1
		27/06/2017	2	0	0
		14/08/2017	2	5	2.5
		08/09/2017	2	3	1.5



## **New Zealand**

Phase 2 collectors deployed in the Bay of Plenty successfully attracted and retained puerulus. CRAMAC 2 also reported that settlement numbers in phase 2 collectors have been relatively high in comparison to the conventional shore-based collectors deployed further south in Gisborne and the Wairarapa.

CRAMAC 2 are constructing additional phase 2 collectors with the intention of increasing the number of collectors being deployed at both sites in the Bay of Plenty.

## **Cost-benefit analysis to establish cost-effective future puerulus monitoring**

Research programs monitoring settlement of larval *Jasus edwardsii* are undertaken in Tasmania, South Australia and in New Zealand. However, diver servicing of the collector habitats used to attract settlers in these programs is both expensive (due to salary, equipment and field costs associated with diving operations), and restrictive to the depth and remoteness of collector deployment. This project offers the benefits of a puerulus monitoring system which does not incur the high cost of regularly deploying a scientific dive team, that is not constrained to dive-able depths, and that is not limited to easily accessible and weather protected sampling sites.

Whilst the initial fabrication of deep-water collectors is more costly than setting up a traditional diver serviced program (Table 14), these costs are more than recouped within the first year of monitoring for an equivalent collector program. Costings are presented for 48 collectors over 3 regions because this replicates the characteristics of the current IMAS inshore monitoring program from which the diver-serviced costs were derived.

The cost differential between diver and industry serviced collectors is primarily due to the high cost of salary, travel, field, and diving services incurred in deployment of IMAS staff to the survey sites. Further, the cost estimates in Table 2 are based on IMAS diver servicing of sites that are easily accessible in trailable vessels. A primary cost benefit of our approach is in utilising vessels from the lobster fleet for collector servicing as they can accomplish this during routine fishing operations. This also provides opportunities for regular monitoring in remote and exposed sites that are targeted in the fishery, but are prohibitively costly to access regularly with a research team.

The deep-water costings include a \$2000 payment to commercial fishers for each servicing event. The advantages of fisheries co-management are well documented, and this project has benefitted from the enthusiastic involvement of a number of fishers in the Tasmanian fleet. A co-management model under which fishers commit to reduce or remove the current payment for servicing will provide further cost benefits.

Table 14 also provides costings for a program with 96 deep-water collectors, including increased fabrication costs and higher fisher payments for servicing. Under this scenario, the additional costs of fabrication incurred would be recouped within the second year of monitoring.

**Table 14: Estimates of the initial setup and ongoing annual costs associated for inshore diver-serviced and deep-water fisher-serviced puerulus monitoring programs for 3 regions on the Tasmanian coast. (Note that the IMAS staff salaries and field expenses included in the costs for deep-water collectors are to fund the administration of the monitoring program including travel to lobster vessels to collect samples, sample sorting, and data processing).**

		Diver-serviced inshore	Deep-water collectors	
		52 collectors – 3 regions	48 collectors	96 collectors
<b>Set up costs</b>	Initial fabrication	21,636.80	35,666.10	62,067.70
	Initial fisher training	-	11,796.45	11,796.45
<b>Ongoing annual costs</b>	Collector maintenance	4,205.21	6,375.40	6,375.40
	Consumables	1,453.00	894.75	894.75
	IMAS staff salaries	77,500.00	1,500.00	1,500.00
	IMAS field expenses	43,100.00	180.00	180.00
	Dive-related costs	7,140.00	-	-
	Payment to fishers for servicing	-	60,000.00	90,000.00
	<b>Total setup year (including 10 service events)</b>		<b>150,829.80</b>	<b>109,857.30</b>
<b>Total annual ongoing (10 service events)</b>		<b>133,398.21</b>	<b>68,950.15</b>	<b>98,950.15</b>

## Value-adding

### Temperature loggers

Participating fishers retained and renewed temperature/depth loggers which were opportunistically attached to deep water collectors during routine service events in each of the sites sampled in Phase 2 of the project.

#### *South west Tasmania – Pyramids*

Water temperature was monitored in the south west region (Pyramids sites) in two depths (60m and 100m) over the 2015/16 puerulus season and revealed high variability and general synchronisation of trends in water temperature by depth. Depth stratification was evident over summer and early autumn, with lower stratification and variability observed over the winter and spring seasons (Fig. 24). Cooler water incursions were evident over short periods (days in early January 2016) and longer periods (weeks in March) as well as a rapid increase and decline in temperature of approximately 4 degrees in mid-February. From September to the end of the time series, water temperatures were slightly warmer at 100m compared to 60m.

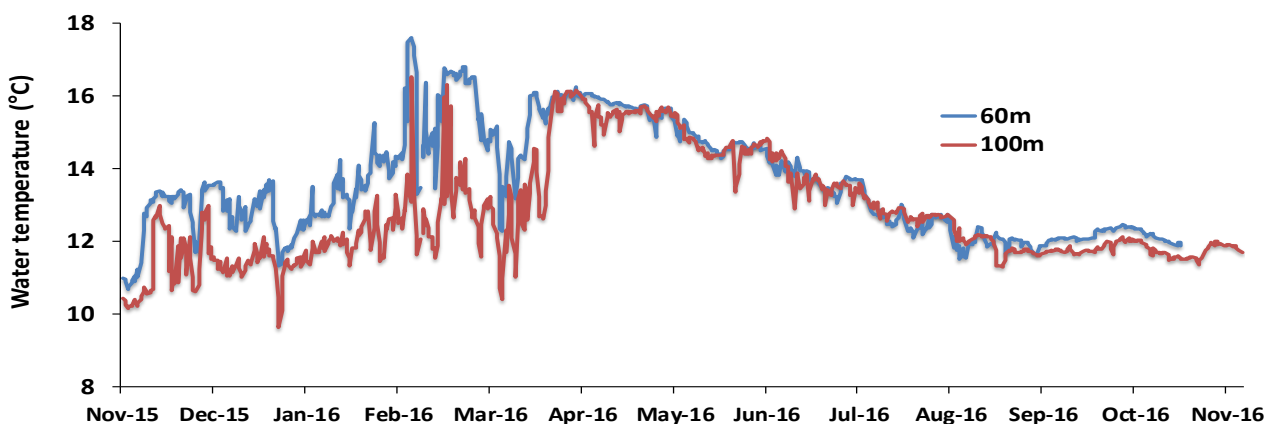

**Figure 24: Water temperature by depth and date at south west sites.**

### **North west Tasmania – King Island**

Water temperature was monitored in the north west region (King Island sites) in two depths (50m and 100m) over the 2015/16 puerulus season. Water temperature was strongly stratified by depth in summer and early autumn, although temperature was more variable in deeper water over this period. Stratification and variability was lower over the winter and spring seasons (Fig. 25).

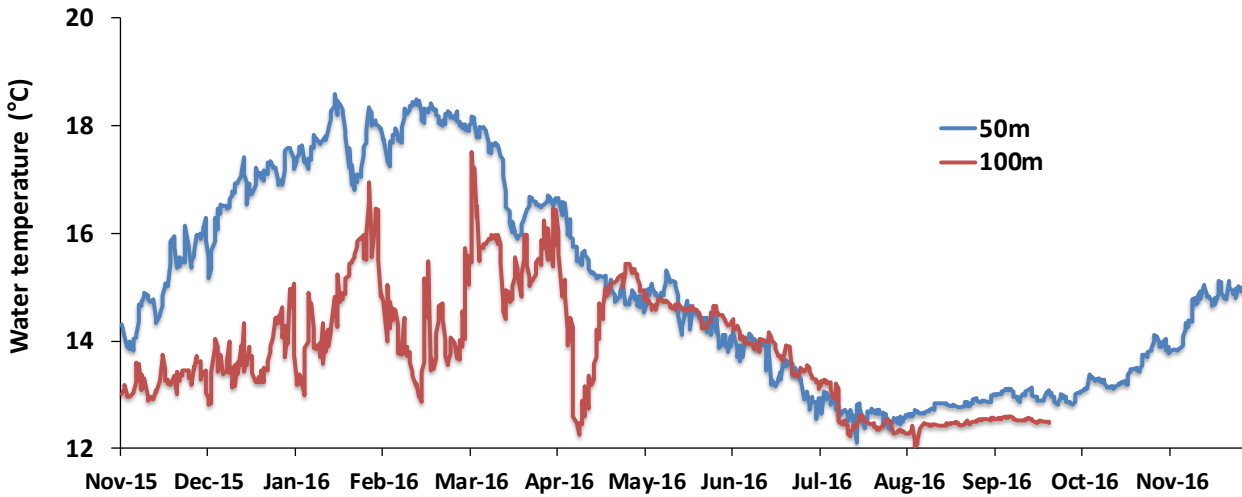

**Figure 25: Water temperature by depth and date at north west sites.**

### **North east Tasmania – Eddystone Point**

Water temperature was monitored in the north east region (Eddystone sites) in two depths (50m and 100m) over the 2015/16 puerulus season. Water temperature was strongly stratified by depth in summer and autumn, although temperature was more variable in shallower water over this period. Stratification and variability was lower over the winter and spring seasons (Fig. 26).

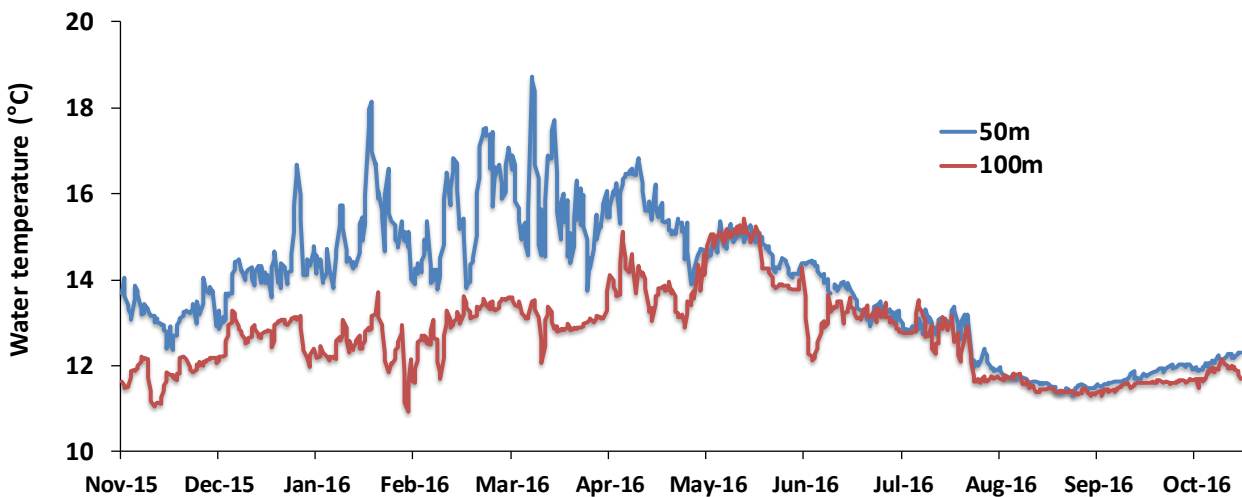

**Figure 26: Water temperature by depth and date at north east sites.**

### ***South east Tasmania – Bruny Island***

Water temperature was monitored in the south east region (Bruny Island sites) in two depths (50m and 100m) over the 2015/16 puerulus season and revealed high variability and general synchronisation of trends in water temperature by depth. Depth stratification was more evident over summer and early autumn, with lower stratification and variability observed over the winter and spring seasons (Fig. 27). Substantial rapid incursions of cold water occurred at both depth zones during February but primarily in the deep water site in late March/early April.

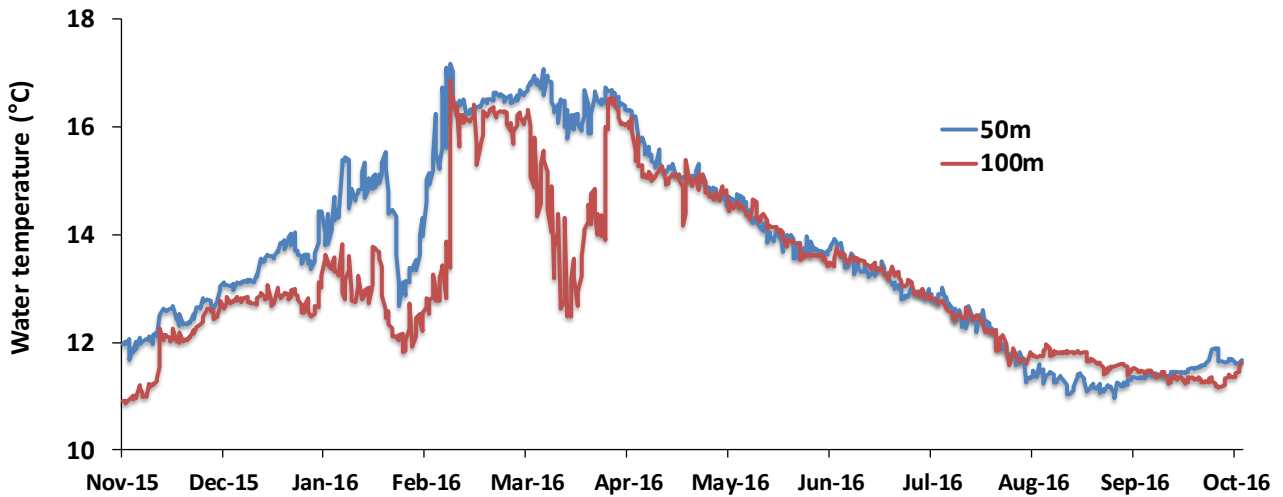

**Figure 27: Water temperature by depth and date at south east sites.**

### ***Eastern Tasmania – Bicheno***

Water temperature was monitored in the eastern region (Bicheno sites) in two depths (30m and 45m) over the 2016/17 puerulus season and revealed high variability in summer and early autumn and general synchronisation of trends in water temperature by depth. (Fig. 28).

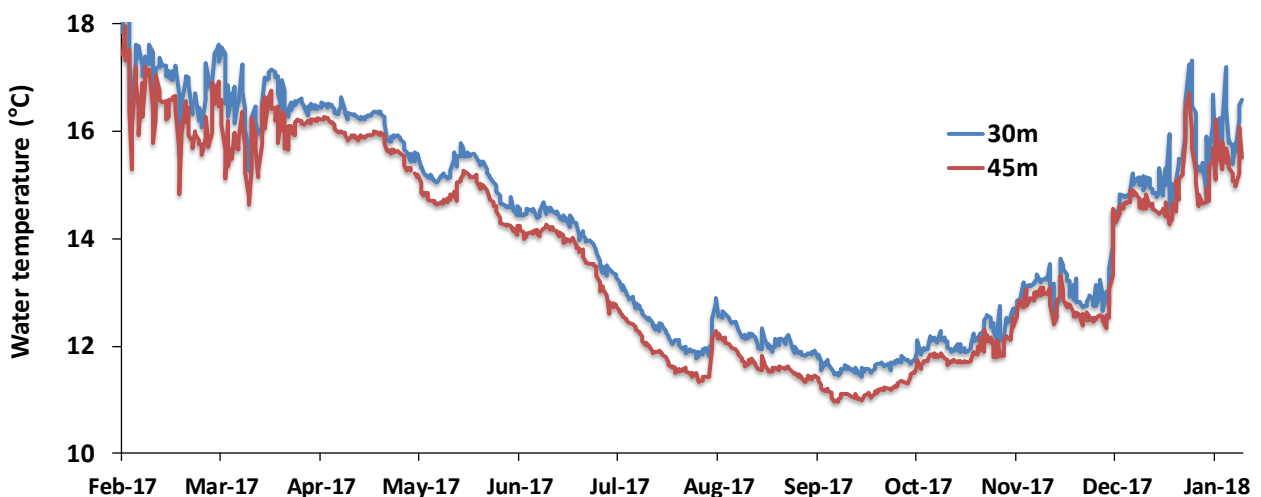

**Figure 28: Water temperature by depth and date at eastern sites.**

### Southern Tasmania – DeWitt Island

Water temperature was monitored in the southern region (DeWitt Island sites) in two depths (40m and 55m) over the 2016/17 puerulus season and revealed high variability and general synchronisation of trends in water temperature by depth. (Fig. 29).

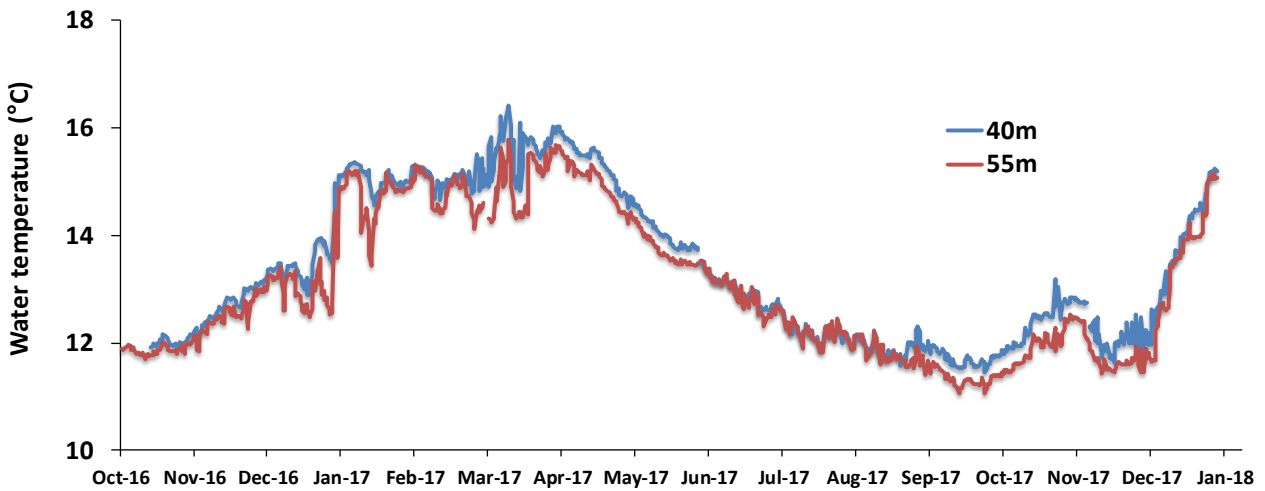

Figure 29: Water temperature by depth and date at southern sites.

The strong settlement event in January 2018 at both the southern Tasmanian inshore sites (Recherche Bay 30.3/collector) and southern offshore sites (DeWitt Island 7.4/collector) was in contrast with inshore and offshore catches in January 2017 (8.6 and 1/collector respectively). Water temperature trends at the DeWitt site in the 2016/17 season show a relatively smooth increase to January 2017 (blue line in Fig. 30). In contrast, the 2017/18 season featured temperatures as low as 11.5°C extending into early December followed by a sharp rise of around 4°C over December to exceed 15°C by January 2018 when recording stopped (red line in Fig. 30).

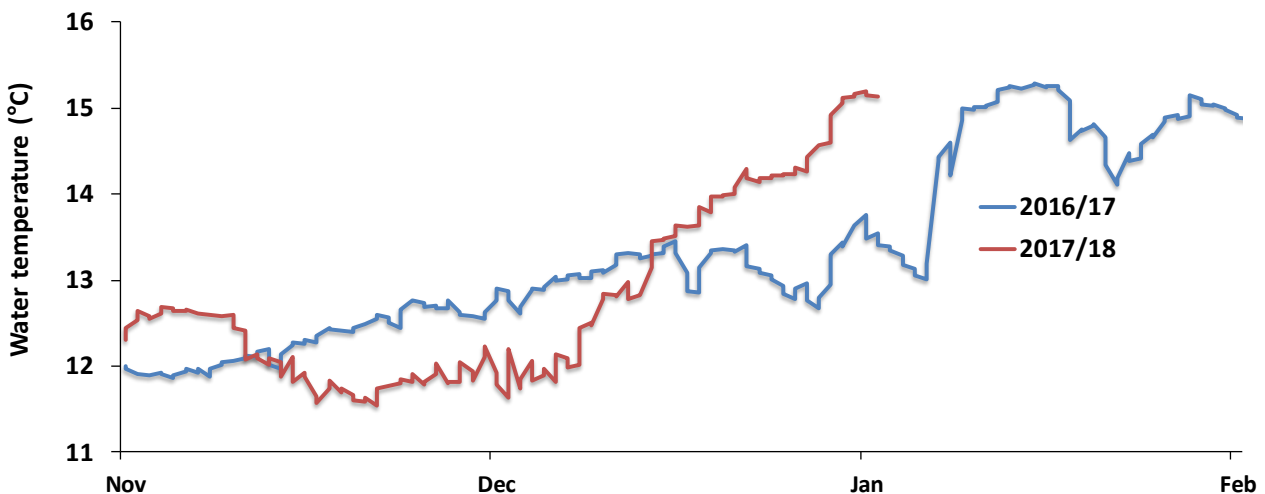

Figure 30: Water temperature at southern sites by date and season.

Within regions, mean seasonal water temperatures were universally highest in autumn and coldest in spring. Temperatures rise slowly from summer to autumn and fall steeply through winter to minima in spring. Deep

and medium depth sites show similar temperatures in the colder season of winter and spring, and become more highly stratified in warmer season of summer and autumn.

Temperatures were highest in the north west region and generally cooler at higher latitudes at the medium depth sites (35-60m) (Fig. 31 A). Interestingly, while the SW was the coolest region in summer, it was the second warmest region during winter. At deeper sites (100m), whilst the north west region was still generally warmer, the latitudinal temperature gradient was less pronounced (Fig.31 B). Surprisingly, the deeper water north east site was colder than the deeper southern sites for most seasons. The west coast sites were also warmer than the east coast sites during winter.

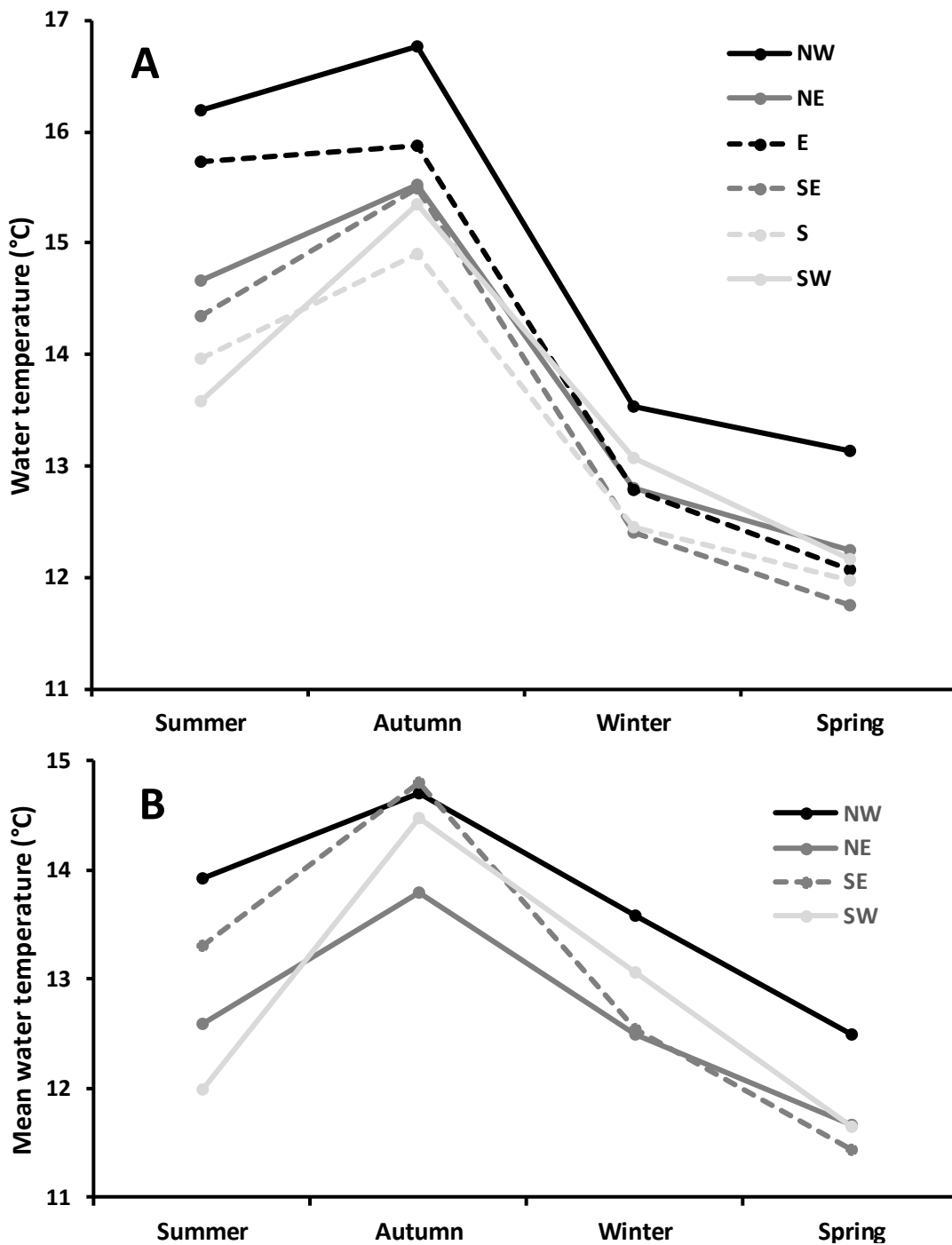
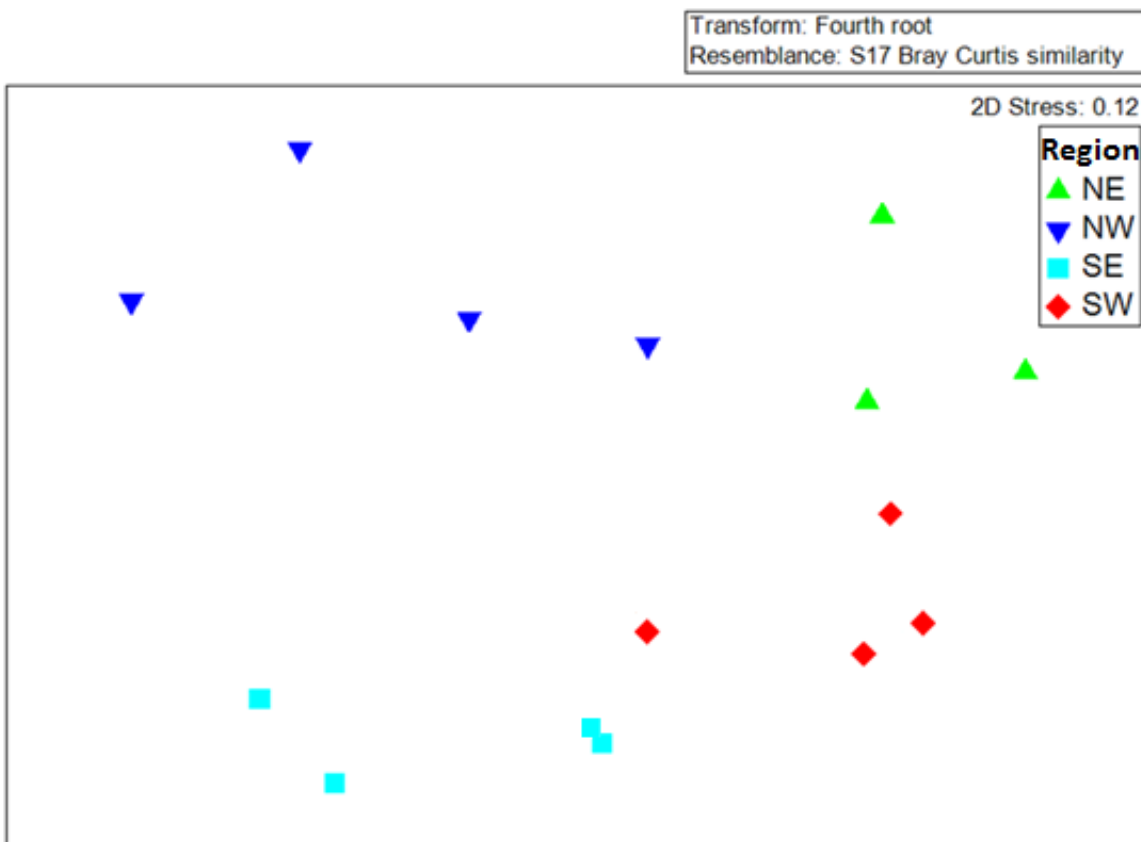

Figure 31: Mean seasonal water temperature from data loggers deployed and serviced opportunistically with deep water puerulus collectors. Mean seasonal water temperatures at the seafloor from medium depth sites are displayed in A (35-60m); temperatures at deep sites are displayed in B (100m).

## Species composition of collector catches

Fishers retained and preserved all fauna encountered in the collectors. A sub-group of samples from each of the 4 regions (NW, NE, SE, SW) and both depth categories (50m and 100m) for summer (February 2016) and winter (August 2016) were sorted to species. A reference collection was collated and temporal variation in assemblages were compared with reference to site and depth (see appendix 5).

Variation in assemblages were compared with reference to site and depth using non-parametric multi-dimensional statistical techniques and displayed clear separation (Fig. 32). This pattern of separation remained the same when rare species were excluded from the analysis and when the analysis was solely based on presence/absence (eliminating abundance issues).



**Figure 32: Multidimensional scaling plot of taxa encountered in the first servicing of collectors around February 2016.**

# Discussion

The deep water collector designs developed and deployed in this project are effective in catching and holding puerulus. Despite changes to the sampling strategy due to very low catches in the first puerulus season of phase 2 (P2), project objectives were still met and additional information was acquired which will be useful for future puerulus monitoring site selection. Value was added to this project by providing a deeper understanding of the ecology of settlement habitats through concurrent servicing of temperature loggers and generation of site specific reference collections from retained fauna encountered on the collectors.

## Comparisons of collector designs

Industry collaborations (Appendix 2), a review of collector designs (Appendix 3), and aquarium and field trials (Ewing et al 2013) informed the development of the P1 and P2 deep water puerulus collector designs. Traditional diver-serviced collector designs require a diver to release the collector from a seafloor anchoring system then to encapsulate the habitat strata in a fine mesh bag prior to hauling to minimise loss of puerulus. The deep water puerulus collector design eliminates the diver components of servicing by first eliminating the need for a seafloor anchoring device through increasing the weight of the collector and deployment in a stable string configuration. Whilst research in shallow inshore Tasmanian waters has shown that losses of puerulus during retrieval of un-bagged collectors are minimal (Mills and Crear, 2004), we considered the potential for flushing of puerulus was greater when retrieving from deeper waters and consequently incorporated a downstream mesh strainer to retain any puerulus flushed from the habitat strata on retrieval.

Eliminating the need for divers during service events reduces risk, cost, and provides the opportunity to deploy in waters deeper than dive-able depths. Given that the majority of Tasmanian commercial rock lobster catches are taken from deeper water on the south and southwest coasts, and that it is unlikely that recruits to the fishery in deep water have migrated from inshore settlers (see Appendix 1), the ability to monitor settlement trends in deeper water provided by this collector design has potential for informing management of the fishery.

Analysis of puerulus catch rates show that the P2 collector design attracts and retains puerulus as well as the P1 deep water collector design and performs better than the traditional diver-serviced design when deployed concurrently in shallow water. Deployments of deep-water collectors in New Zealand also showed improved catch rates relative to traditional collectors and in deep-water collector deployments and deployments in South Australia showed equivalent catch performance between diver-serviced and concurrent adjacent deployments of deep-water collectors. Observations of the P1 and P2 collector designs deployed in shallow exposed sites at Bicheno showed siltation of approximately half of the settlement strata after a significant swell event. This suggests that while the deep water collector designs successfully collect puerulus, modifications will be required for deployment into exposed shallow unconsolidated habitats.

Modifications for use in shallow waters would include incorporation of a mesh floor on the base of the collector frame to minimise sinking into unconsolidated sediments and increasing the height above the seafloor of the substrate. The latter modification is a more challenging re-design as the self-righting and compact design would need to be retained to maintain the capability of the collectors to be retrieved and serviced by the commercial fleet with standard deck equipment.

## Spatial and depth trends in settlement

Concurrent deployments of collectors at various locations and depths around Tasmania allowed examination of spatial patterns in settlement. These comparisons were restricted to the 2012/13 and 2016/17 settlement seasons due to the lack of statistical power of negligible catches in deep water in the 2015/16 season. Whilst these very low catches may legitimately reflect low numbers of settlers (inshore shallow catches were also low), they were too low to provide meaningful comparisons of spatial trends.



## Depth

Catches were strongly structured by depth with the deep depth category (D) sites (>100m) providing a total of only two puerulus over the entire sampling regime. Medium depth categories (MD and MS) provided around an order of magnitude lower catches than inshore shallow sites (SH). Falling puerulus settlement rates with increasing depth has also been observed in other studies on *J. edwardsii* settlers. For example, Booth *et al.* (1991) established that *J. edwardsii* pueruli settled to depths of at least 50m, that settlement increased with depth to around 10 to 12m, after which it decreased with increasing depth and distance from shore.

This depth relationship makes sense in the context of the desirability of higher productivity settlement habitats inshore and the natural barrier to migration that the shoreline presents. However, *J. edwardsii* are present in significant densities in deeper waters as demonstrated by around 30% of landings in the fishery on the Tasmanian west and southwest coasts taken in waters deeper than 60m (Hartman *et al.*, 2012). Given significant densities of *J. edwardsii* in deeper water, and clear evidence of higher settlement in shallow water, lobsters must either settle inshore and then move to deeper water, settle directly into deeper water, or both.

Settlement of puerulus inshore on specific shallow water habitats, with subsequent migration offshore and/or upstream to adult habitats, is a life-cycle common in palinurid lobsters (Phillips, 1983; Booth, 1997; George, 2005; Phillips *et al.*, 2007). However, puerulus from some palinurid species are known to settle directly into deep water adult habitats (Polovina *et al.*, 1995). Puerulus of *Jasus spp.* swim strongly from offshore and shelf slope habitats, actively seeking settlement habitats (George, 2005).

If movement after settlement from shallow inshore sites is responsible for the populations of larger lobsters on deeper water sites, this movement could be either migratory (directed and temporally discreet), or nomadic (wandering lacking directedness and temporal confinement). Research using acoustic telemetry to measure medium-scale movement of *J. edwardsii* on inshore reefs in New Zealand reported that, although exhibiting home-range movements associated with moulting, reproductive and feeding cycles, *J. edwardsii* display high site fidelity with a maximum recorded range of 3.1km (MacDiarmid *et al.*, 1991; Kelly, 2001; Kelly and MacDiarmid, 2003). Whilst trap-based tag and recapture methods of detecting movement are insensitive to small scale movements (Booth, 1997), such studies can be used to detect large scale migratory or nomadic movements (Gardner *et al.*, 2003). Trap-based mark and recapture studies of *J. edwardsii* in New Zealand waters have shown clear evidence of alongshore, contranantant movement and this movement is mostly in juvenile females approaching maturity and similarly sized males (Booth, 1997).

Analysis of tag recapture data of *J. edwardsii* in Tasmanian waters (~40,000 recaptures) shows little evidence of large-scale unidirectional or nomadic movement, but some evidence of seasonal movements associated with moulting of males and larval release by females (Gardner *et al.*, 2003; Barrett *et al.*, 2009). For example, on the south west coast of Tasmania tag recapture data indicates a 10% movement from shallow to deep water, and a 39% movement from deep to shallow (Green *et al.*, 2012). Whilst the size selectivity of the traps used for this research has been shown to vary with sex and season (Ziegler *et al.*, 2002), the trap selectivity of lobsters >80mm carapace length (CL) is considered sufficient to conclude that if offshore movement is responsible for the density of *J. edwardsii* in deeper sites, it must be due to movement of small post settlers (< 80mm CL).

Early juvenile palinurid lobsters are very vulnerable to predation, which they counter with cryptic behaviour and by sheltering in complex micro-habitats (Groeneveld *et al.*, 2010). Nomadic short-distance movements to find increasingly larger close-fitting holes and food-items are necessary for fast growing small juvenile lobsters (Booth, 2001), but are unlikely to involve movement over larger distances due to increased risk of predation. This is particularly the case in Tasmania as movement into deeper waters generally entails movement to habitats of lower productivity than those inshore (Gardner *et al.*, 2006), and in some locations entails migration across extensive areas of soft sediment. Further, of the palinurids that do migrate offshore from settler habitats, this movement occurs at, or just prior to, maturity (Kanciruk, 1980), rather than in early juvenile post-settlement phases.

Extensive Tasmanian tagging studies provide no evidence for a systematic offshore migration in adult or near mature *J. edwardsii*, and a systematic migration of young juveniles is inconsistent with observed

behaviours and would carry a very high risk of predation. Consequently, it is likely that populations of adult *J. edwardsii* encountered on deeper reefs have originated largely from puerulus settling directly in deeper waters. Given the evidence for lower settlement in deeper waters, recruits targeted by the fishery in deeper water are likely to have originated from much lower levels of settlement than the inshore fishery. Of course other factors such as differences in mortality of settlers by depth will also influence the resultant biomass of recruits to the fishery (Gardner et al 2001). Nonetheless, this strengthens the case for acquiring an understanding of the extent to which recruitment mechanisms vary between deep and shallow waters.

Cues to metamorphosis from phyllosoma to puerulus are thought to involve threshold energy states sufficient to allow a non-feeding puerulus to swim ashore (Phillips and McWilliam, 1986) and possible environmental triggers for *J. edwardsii* (Jeffs et al., 2001). Studies of the lipid reserves in *J. edwardsii* pueruli on the outer shelf in New Zealand found that over 15% had insufficient energy reserves to reach inshore settlement sites (Jeffs et al., 2001). The inshore migration of *J. edwardsii* pueruli across the shelf, also involves a diurnal vertical migration with daytime spent on the seafloor and night-time spent at the surface (Booth and Phillips, 1994; Jeffs et al., 2001). Puerulus are known to utilise surface onshore currents to assist their migration to inshore waters (Groeneveld et al., 2010), with pulses in inshore settlement corresponding with down-welling events.

Consequently, it is likely that *J. edwardsii* pueruli encounter the sea floor at various points on the shelf due to diurnal vertical migration and/or insufficient energy reserves to reach inshore waters. Further, unfavourable surface currents would be likely to increase the number of encounters with the seafloor due to slower progress across the shelf and an increased likelihood that energy reserves would be depleted prior to reaching inshore waters. Habitat selection of invertebrates has been shown to be driven by factors such as the presence of conspecific adults, other new recruits, other taxa (such as prey species) and the type and texture of substrates. Booth (2001) reported that *J. edwardsii* chose suitable shelter above these other factors.

Given the lack of evidence for post-settlement migration in Tasmanian waters, the likelihood that puerulus encounter structured habitats suitable for settlement in deeper water whilst migrating inshore, and the primary importance of shelter quality in selection of settlement habitats, it is likely that *J. edwardsii* settle directly onto deep water reefs. Further, settlement rates in deep water may vary relative to shallow settlement rates on the basis of factors which influence the likelihood of pueruli having sufficient energy to migrate to inshore waters for settlement. These factors may include the distance from the shore at which metamorphosis from phyllosomata occurs, the lipid content of puerulus, the surface current conditions in shelf waters, and the occurrence of suitable settlement strata in shelf waters.

The evidence in this study of settlement in deeper water, but at a lower rate to inshore waters. While this is consistent with the findings of previous studies mentioned above, they do not account for the spatial extent of offshore regions and total settlement may be greater offshore. The relative variation detected in the temporal trends of settlement between inshore and offshore collectors supports the hypothesis that factors affecting relative settlement rates are also likely to vary temporally. For example, particularly high settlement detected in January 2018 in southern Tasmanian sites showed relatively higher catch rates in deeper water than at other times. Further, site selection will also influence relative catch rates. For example, numerous inshore sites were trialled and discarded due to very low settlement rates during the initial selection of Tasmanian inshore diver-serviced monitoring sites. Consequently, further refinement of site selection for offshore monitoring may yield higher catch densities although the current densities were sufficient to detect changes in settlement trends similar to inshore collectors.

## Region

The spatial comparison of deep sites conducted in this study showed higher settlement rates from the south coast sites than from the east coast sites, but these differences were not statistically significant due to high intra-seasonal variation in settlement rates. Settlement of *J. edwardsii* pueruli in shallow inshore waters (<10m) is well documented with long-term research programs monitoring settlers in southern Australia and New Zealand, and long-term diver-serviced inshore monitoring in Tasmania has revealed considerable spatial variation in settlement (Gardner et al., 2001; Cohen and Gardner, 2007; Hinojosa et al., 2016a). Further, Hinojosa (Hinojosa et al., 2016a) suggests that due to the complexity of settlement processes

involving larval behaviour, biological factors and oceanographic processes, environmental conditions that reduced settlement strength in one region often increased settlement strength in other regions. Increased settlement rates in both inshore and offshore sites observed on the south coast relative to the east coast are consistent with this hypothesis.

## Reef proximity

For the first two seasons sampled (2012/13 and 2015/16) deep water puerulus collectors were deployed on soft sediment habitats and such that no collector was within 1km from known reef habitat. The rationale for this collector deployment strategy was to minimise the likelihood of snagging the ground-lines on protuberant reef and to maximise the attractiveness of the habitat strata to settlers due to the absence of nearby reef habitat suitable for settlement. However, very low catch rates from deep water deployments in the 2015/16 settlement season prompted consideration of other factors that may influence puerulus settlement and hence collector placement. For example, Hinojosa (Hinojosa *et al.*, 2015; Hinojosa *et al.*, 2016b) found that puerulus were attracted to reef habitats for settlement on the basis of chemical and sound cues.

Subsequent re-deployments of deep water collectors on the east and south coasts of Tasmania did not find any significant differences on the basis of proximity to reef and supported the conclusion that low offshore settlement rates in the 2015/16 season were most likely due to low numbers of settlers rather than site selection factors.

## Temporal trends in settlement

Settlement of *J. edwardsii* pueruli in shallow inshore waters (<10m) is well documented with long-term research programs monitoring settlers in southern Australian and New Zealand and long-term diver-serviced inshore monitoring in Tasmania has revealed considerable temporal variation in settlement (Gardner *et al.*, 2001; Cohen and Gardner, 2007). The seasonal comparisons conducted on deep water sites suggested that the 2012/13 and 2016/17 seasons were similar in settlement rates but were dramatically different to the 2015/16 season during which settlement in deeper water was negligible. Whilst only 2 months were monitored at the beginning of the 2017/18 season, catch rates were at unprecedented high levels also indicating high temporal variation in settlement.

A temporal comparison of inshore settlement rates with deep water rates was conducted to further explore whether deep water sites could be used as a replacement for inshore sites. A very strong correlation was observed between the south coast inshore and offshore sites over the 4 seasons sampled. This close conformance suggests that deep water puerulus monitoring will provide recruitment signals present in inshore settlement data; presumably on the basis of similar processes driving fluctuations in inshore and offshore settlement rates. Despite settlement in deeper water occurring at lower levels than inshore (generally around one tenth of the magnitude of adjacent inshore settlement), statistically significant correlation between bimonthly settlement inshore and offshore and statistically significant seasonal differences detected offshore indicate that offshore arrays are also able to effectively measure temporal trends in settlement of puerulus.

Two offshore sample events showed relatively high settlement relative to inshore settlement (March 2017 and January 2018). This suggests that whilst processes structuring inshore and offshore settlement are often aligned, there are occasions when processes favour offshore settlement. Water temperature data from the southern deep sites show low temperature (<12°C) extending to the beginning of December followed by a steep rise in temperature over December 2017 indicating that the region was being flooded by warm East Australian Current waters. At the time of the strong settlement event in early January 2018, water temperatures had risen sharply to over 15°C. Although not as pronounced, there was also considerable variation in water temperatures in March 2017.

As early benthic phase puerulus are known to actively search for suitable crevices and to consume small fauna (Edmunds, 1995; Butler *et al.*, 1999; Frusher *et al.*, 1999; Booth, 2001; Caputi *et al.*, 2013), another possible explanation for lower detected settlement in deeper sites could be lower retention time of settlers

due to less favourable conditions relative to more heavily fouled inshore collectors. However, the presence of approximately 50% pigmented puerulus on collectors at both the DeWitt (deep) and adjacent Recherche Bay (shallow) sites in January 2018 indicates that retention times are similar between offshore and inshore collector systems.

## **Cost-benefit analysis to establish cost-effective future puerulus monitoring**

Routine diver-serviced inshore puerulus monitoring is a costly undertaking due to the workplace health and safety framework required to ensure that the risks inherent in dive operations are managed, and due to the cost of accessing monitoring sites. However, assessing the relative cost-effectiveness of the alternative fisher-serviced puerulus monitoring approach investigated in this project, depends on the purpose of future monitoring programs. Consequently the costings will be compared under three monitoring scenarios.

### **Replicate or replace inshore monitoring with offshore fisher-serviced monitoring**

Temporal comparisons suggest that trends in offshore catch rates will reflect trends and variance in inshore catches most of the time, but at approximately one tenth of the inshore catch rate. Replacement of diver-serviced inshore monitoring with offshore deployments of deep water collectors is a very cost-effective alternative to inshore monitoring with a reduction in the annual cost of the program within the first year of operation. Further, even an expansion to double the number of collectors (96 collectors) would be less expensive than the diver-serviced inshore program within its second year of operation.

The majority of the costs in the subsequent ongoing monitoring offshore are payments to fishers. The advantages of fisheries co-management are well-documented, and this project has benefitted from the enthusiastic involvement of a number of fishers in the Tasmanian fleet. Deployments and service events of the deep-water collectors developed in this project, in South Australian and New Zealand precincts, were accomplished with local industry support with no conditional financial compensation. A co-management model under which Tasmanian fishers also commit to service collectors without compensation would dramatically reduce the annual costs for ongoing maintenance. Under this scenario the costs of the monitoring program would be a fraction of the costs incurred under the current diver serviced model.

### **Replicate or replace inshore monitoring with inshore fisher-serviced monitoring**

As deep water collectors catch puerulus at similar rates to diver-serviced methods when deployed inshore, the same number of collectors (around 50) would be required to replace inshore arrays with deep water collectors. Replacement of diver-serviced inshore monitoring with inshore deployments of deep water collectors is very cost-effective with a reduction in the annual cost of the program within the first year of operation.

However, the current deep water puerulus collector would require design modifications to reduce sedimentation in exposed sites on mobile unconsolidated substrates, and reduce movement in shallow swell-exposed locations. This would require industry liaison as a modified design to raise the height above the sea-floor would need to ensure maintaining the collectors' self-righting properties and the ability to be serviced by standard deck gear on commercial lobster vessels. Thus a period of development and testing would ensue additional costs.

### **Complement existing inshore monitoring with fisher-serviced offshore monitoring**

A primary advantage of the fisher-serviced offshore monitoring approach investigated in this project is the ability to monitor remote and exposed areas that are frequented by vessels in the commercial fleet but that would be impractical (or impossible) and/or onerously expensive to monitor by research diver-serviced methods. Whilst this analysis does not attempt to cost traditional monitoring at such locations, there is an identified priority to investigate options for puerulus collection on the south and west coasts using the commercial fleet to reduce the cost of collection.

The methodology developed in this project is currently the only available method to monitor puerulus settlement in remote exposed locations and as such is the only way to address this identified priority. In utilising the commercial fleet that regularly visit such locations, this method also offers excellent cost benefits.

Consequently, this methodology offers a very cost-effective way to expand the existing collector fleet to address the identified priority of monitoring settlement on the Tasmanian south and west coasts where the majority of landings are captured.

## Value-adding

Utilising the commercial lobster fleet to service puerulus collectors in remote exposed areas of the fishery provides opportunities for value-adding with valuable routine monitoring able to contribute to areas of specific research interest such as climate change research (eg. biological range-shifts and other responses of faunal assemblages to warming), fisheries research (eg. regional drivers of recruitment variability), and physical oceanographic monitoring.

This project realised two such value-added research outcomes through the deployment of temperature loggers and taxonomic analysis of collector catches.

## Temperature loggers

Temperature data collected opportunistically by participating commercial fishers revealed a general latitudinal gradient of water temperature at the seafloor with warmer waters at northern sites (particularly in the north west region) and cooler temperatures in southern sites; although this trend was less pronounced at deeper depths. Whilst fluctuating over short temporal scales, for every region water temperature was highest in autumn, fell steeply through winter to minima in spring and then rose slowly through summer.

Within regions water temperatures were similar across depth gradients during colder months (winter and spring), and were more stratified over warmer months (summer and autumn). Depth stratification of water temperatures closed earlier in southern sites (March), than in northern sites (May). Whilst short term fluctuations in temperature were more pronounced in the warmer months, generally temperatures co-varied by depth within regions. Despite this relationship, regional differences in trends of temperature by depth, and distinct temperature events within depth strata were evident in temperature records. For example, the south west region showed low stratification and strong depth co-variation. Conversely, the north west region was highly stratified during warmer months, displayed greater variation in temperature at the deeper sites, and displayed temperature trends which were, at times, completely un-coupled by depth. The north east was also highly stratified during warmer months, but displayed greater variation in temperature at the shallower sites.

Local hydrodynamic factors, including up-welling and eddies associated with Bass Strait and the Tasmanian sub-antarctic convergence (East Australian Current, Zeehan Current and waters of sub-antarctic origin) will strongly influence temperature by depth on the Tasmanian coast (Harris *et al.*, 1987) and the fluctuations observed in this study are likely to be associated with these influences and the impact of local weather systems.

Distributions of *J. edwardsii* eggs and phyllosoma off the Tasmanian coast are also known to be influenced by the sub-antarctic convergence (Bruce *et al.*, 2000) and puerulus are known to utilise surface onshore currents to assist their migration to inshore waters (Groeneveld *et al.*, 2010), with pulses in inshore settlement corresponding with down-welling events.

This project observed a very strong settlement event in southern Tasmania in January 2018 at both inshore and offshore sites in comparison to low catch rates in January 2017. A comparison of temperature profiles between these settlement seasons revealed a dramatic contrast in temperature trends with unusually cold temperatures persisting into mid December 2017 followed by a steep increase in temperature into January 2018 to unusually warm water temperatures. A longer time-series of water temperatures and puerulus

settlement rates would provide opportunities to examine the hydrodynamic influences on larval supply to settlement and potentially provide additional parameters for predictive settlement models.

Lobsters are exothermal and rely on the external water temperature to regulate their metabolic processes and water temperature also influences movement, feeding and reproductive success. Catch rates of lobsters are also strongly linked to water temperatures with higher catch rates in warmer summer and autumn months.

Consequently, generating data series of water temperatures by depth around the Tasmanian coast will contribute to a better understanding of both puerulus settlement dynamics, and recruitment and catchability of adult lobsters in the fishery; and deployment of temperature loggers on industry-serviced puerulus collectors will provide this data cost-effectively. For example, the Fishermen and Scientists Research Society of Canada attach temperature loggers to their scientific traps to record bottom water temperatures throughout their lobster season and temporal trends and patterns are now used in lobster and other fishery assessments due to correlation between temperature events and catch rates (Baker, 2017).

## **Species Composition**

There are clear spatial patterns in faunal assemblages (Fig. 32). These patterns can be due to:

1. large numbers of dominant species being present in specific locations (i.e. the same animals distributed across all sites but their abundance varying by site), or
2. a few rare species (i.e. the common species and their abundances similar across regions with a few rare species varying by site)

The pattern of separation remained the same when rare species were excluded from the analysis, and when the analysis was solely based on presence/absence (eliminating abundance). This indicates a clear differentiation between regions and suggests that the deeper-water habitats in the NE, NW, SE and SW regions of Tasmania are distinctive and would therefore provide different prey and predator relationships for puerulus. They also indicate that the physical characteristics of the regions are sufficiently different to support different ecosystems.

The ability to detect distinct faunal assemblages inhabiting puerulus collectors around the Tasmanian coast promotes the use of time-series of such data to measure ecological shifts over time and by depth. These data can be an important and cost-effective component of monitoring impacts to Tasmanian marine ecosystems in response to ocean warming and acidification. Changes in these ecosystems are expected to impact the productivity of reef systems and their inhabitants, including rock lobsters.

## Conclusions

This project has generated a collector design that:

- Collects puerulus as effectively as traditional diver-serviced inshore collector systems
- Collects puerulus effectively from deep water (>25m)
- Can be easily and safely deployed, retrieved and serviced by vessels from the Tasmanian commercial lobster fleet during routine fishing operations

Deployments at various locations around the Tasmanian coast over 4 settlement seasons have shown that:

- Puerulus settlement is lower in deeper offshore waters than in shallow inshore waters although sufficient to demonstrate major changes in recruitment.
- Puerulus settlement in deeper waters was higher in the 2016/2017 settlement season on the south coast of Tasmania than it was on the east coast
- Puerulus settlement rates in deep waters varied between recent seasons similarly to settlement in inshore waters

A cost-benefit analysis comparing traditional diver-based and deep-water fisher serviced puerulus collection strategies has shown that:

- Fisher-serviced is more cost-effective than diver-based methods for similar arrays of collectors
- The current fisher-serviced design is not suitable for deployment in inshore shallow exposed waters without further refinement due to sedimentation from mobile sediments
- The fisher-serviced collection system developed in this project is a cost-effective way to monitor puerulus settlement in deep water and particularly in exposed, remote locations
- Despite yielding lower catch rates than inshore settlement monitoring, offshore collectors displayed similar temporal patterns of settlement
- Fisher-serviced puerulus monitoring would be much more cost effective if industry agreed to provide support without the requirement for financial compensation

Opportunistic data collection conducted in collaboration with industry-supported puerulus monitoring has shown that:

- Additional time-series datasets can be harvested very cost-effectively when partnered with existing puerulus monitoring programs
- Temporal temperature monitoring from puerulus collection sites will provide useful data for understanding lobster recruitment processes and hence for evidence-based management of lobster fisheries
- Puerulus collectors can provide evidence of spacio-temporal shifts in ecological assemblages through monitoring of faunal inhabitants
- These data can be an important and cost-effective component of monitoring impacts to Tasmanian marine ecosystems in response to ocean warming and acidification

# Implications

Monitoring the recruitment of recruits or young-of-year has always been a priority for fishery management as it is most often the first time that there is an indication of the future recruitment to the fishery. Lobster fisheries have been successful at monitoring puerulus settlement to provide an early indication of future recruitment to the fishery. However, the early life-history stages of puerulus vary from species and puerulus of the species *Jasus* settle on rocky reefs inhabiting small holes and crevices.

Traditional monitoring has required specialised techniques and equipment associated with diving to monitoring artificial habitats that are placed in shallow protected coastal regions. While these have proven useful for appropriate protected regions they require industry to be reliant on paying specialists to service the collectors.

This project has provided a mechanism by which industry can monitoring recruitment with costs associated with their initial costs of construction of the collectors and their time in servicing and reporting. As such, industry is able to operate and/or extend a system that monitors puerulus without the need and costs of involving a third party. This also enables the industry to monitor in regions that are important fishing grounds but not previously amenable to coastal dive servicing. The cost-benefit analysis demonstrates that this is a cheaper option.

It was encouraging to see the South Australian Industry trial the collectors, albeit in shallow waters, in their northern zone and for New Zealand to construct, deploy and trial collectors in some of their lobster fishing zones. The positive results from the NZ deployments has resulted in expansion of these deployments by the NZ fishing industry to other regions.

The collectors also offer the opportunity to attach other monitoring equipment such as sensors that measure temperature and salinity and with technological improvements, other sensors monitoring water condition (e.g. nutrients). During this project we measured temperature and were surprised to see how variable the water temperature was in deeper water. Monitoring water parameters over the spatial scale of the southern rock lobster fishery may provide both small and large scale conditions under which puerulus settle and provide valuable insights into the timing and conditions for variability in puerulus settlement. Monitoring of set sites can also provide important information on the impacts of changes in the environment due to warming coastal waters and changing current systems. Such information is not only of benefit to the industry but also to the broader marine community and would demonstrate good custodianship of the marine environment by the industry (see recommendations).

# Recommendations

Industry need to determine their interest in pursuing the monitoring of puerulus through their involvement. Initially this should be done in consultation with a research provider to enable a robust design to be determined and finalised (see future development).

We have proposed two honours projects utilising data gathered from this project. The first is to compare the water temperature graphs with commercial catch rates in similar locations and at similar depths. This is to determine if the dynamics of the water temperature time series (both rapid and gradual changes) can help explain changes in lobster catchability. The second project focuses on comparing the settlement of non-puerulus organisms on the collectors. As each collector was serviced, the fisher placed the entire contents of the collectors in containers which are preserved and stored at IMAS. Analysis of these samples will build on the initial analysis undertaken in this project from a small number of collections at two discrete time intervals. Outcomes from this analysis will include an increased knowledge of deeper water species distribution and provide a base line for future comparisons. As many of the species have different life-history characteristics including larval dispersion mechanisms, an analysis of the data may demonstrate connectivity between different regions at different depths (i.e. 50 and 100m) and provide additional information on sub-surface currents. Some of these species may be food and future research may be able to link lobster dietary intake (e.g. DNA analysis – see FRDC report 2004-013).



# Further development

This project has provided a means by which industry can monitor puerulus settlement. However, the settlement in deeper-water is less than in shallower waters (especially during high settlement periods) although similar trends are still evident. It also allows for monitoring in regions that previously were unsuitable due to logistics, costs or suitability (e.g. west coast of Tasmania).

As with the initial shallow water traditional collectors, it appears that there are areas that are better suited for collecting puerulus (i.e. have higher settlement rates) than others and more work is required to identify these locations. If industry wishes to replace the traditional collectors, there is the need to monitor the industry collectors concurrently with the traditional collectors for a minimum of at least two years. During this period considerable variation in settlement between years and months would be required to determine a linkage between the two monitoring systems and be able to use both time series.

This project saw trials undertaken in Tasmania, South Australia and New Zealand. Once each state (and potentially Victoria, WA and NSW) have established reliable servicing systems (e.g. people and time), there is the opportunity to develop a broad southern rock lobster puerulus monitoring system across the entire range of the fishery.

A key issue for industry monitoring has been obtaining regular and reliable servicing. While we are very appreciative of the efforts undertaken by the fishers involved in the project to service the collectors at regular intervals, we acknowledge that this is not always possible. The decisions by fishers to be in specific regions at certain times vary with weather and catch rates amongst other variables. During the first phase of this project we trialled an underwater camera system that could relay images back to a shore base. Further development of underwater camera systems offer a mechanism of obtaining greater detail (e.g. daily settlement rates) and with declining technology costs, a cost-effective way of monitoring that requires limited routine maintenance. Further research into the use of remote servicing should be investigated.

Through connections to some of the other ocean monitoring systems (e.g. IMOS in Australia) there is the opportunity for sensor data (e.g. temperature, salinity, nutrients, dissolved oxygen etc) to be collected and managed by these larger monitoring programs. Data stored and made publically available through these systems will also provide an opportunity to link with other data sets (e.g. satellite images, current profilers etc) to provide an increased understanding of the dynamics of ocean waters inhabited by puerulus and adult lobsters. For example, change in catchability maybe related to a specific combination of environmental events both in the short term (e.g. rapid change in temperature over short periods) or longer periods (e.g. potential food supply).

## Extension and Adoption

The deep water collector system has been a joint industry-research initiative with strong industry participation in the design, deployment, servicing and retrieval of the collectors. Trials of these collectors have also been undertaken by industry in South Australia and New Zealand with promising feedback from these industries. The following is from an email received from Mr Daryl Sykes, NZ rock lobster on the 29<sup>th</sup> May, 2017

*Ten more collectors have been manufactured and are being deployed. Advice from our stock assessment science team was to deploy in batches of three at locations well apart – and to move collector sites if we don't see colour. The CRAMAC 2 guys have decided three moon phases as the 'test period' and they are setting collectors apart at twice the depth of the location.*

*The new collectors are being deployed at sites north of our first array to the boundary of the Hauraki Gulf. CRAMAC 2 will expand coverage once they are confident that the collectors are routinely 'fishing'.*

*I have a few new photos of the collectors under construction and of juveniles recovered. If they are useful to your report please let me know. Something you may want to mention is that the CRA 2 industry*

*representatives are very supportive of the project and very encouraged with preliminary results – they have made a financial commitment to maintaining a time series of data from the deepwater collectors.*

Continued use by the Tasmanian Rock Lobster Fishermen's Association will be a decision undertaken by that organisation. We are pleased that when the collectors were transferred from the NE to the SE partway through this project to investigate sampling design, the NE fisher has continued to collect the water temperature data.

A presentation was given at the annual general meeting of the TRLFA (November 2016) and to the Southern Rock Lobster Committee (2016). Outcomes of the last collection and the final outcomes will be through Fishing Today and dissemination of the FRDC final report. Outcomes from the two honours projects mentioned under recommendations will be provided to the scientific representative on the rock lobster advisory committee to be provided to industry and management.

## Project coverage

Over the life of Phase 2 of this project, opportunities have been realised to extend the aims, progress and results to the commercial Rock Lobster sector (including fishers, fisheries managers, research scientists and processors), and to the wider marine community both nationally and internationally. Extension has included:

- Media release: Researchers team up with industry to forecast future rock lobster catches - August 2015
- Article: Fishing Today (Tas): State-wide larval lobster settlement monitoring - October 2015
- Article: Lobster Newsletter (WA): An industry-serviced puerulus collector suitable for deep water - Volume 28, no. 2
- Article: Southern Rock Lobster News (AUS): An industry-serviced puerulus collector suitable for deep water – Volume 29
- Presentation: World Fisheries Congress: Creating win-win scenarios for longer term monitoring of the marine domain? – May 2016
- Presentation: Australian Society for Fish Biology: Creating win-win scenarios for longer term monitoring of the marine domain? – September 2016
- Presentation: Tasmanian Rock Lobster Fisherman's Association: Project update and preliminary results - October 2016
- Report: to Southern Rock Lobster Limited for their research and development meeting: Progress on FRDC 2014/025 trialling an industry-serviced puerulus collector – April 2017
- Article in prep: Fishing Today (Tas): Outcomes and conclusions from FRDC/IMAS project 2014/025 trialling industry-supported puerulus settlement monitoring
- Article in prep: Lobster Newsletter (WA): Outcomes and conclusions from FRDC/IMAS project 2014/025 trialling industry-supported puerulus settlement monitoring
- Article in prep: Southern Rock Lobster News (AUS): Outcomes and conclusions from FRDC/IMAS project 2014/025 trialling industry-supported puerulus settlement monitoring
- Manuscript in prep: Primary literature: Cost-effective industry-supported puerulus monitoring with fringe benefits

# Project materials developed

In collaboration with Tasmanian commercial lobster fishers, this project successfully developed a puerulus collector capable of deployment and servicing by commercial Tasmanian lobster vessels. The collector design:

- Attracts and retains puerulus from depths up to 100m
- Retains puerulus during retrieval to the surface
- Collects and retains puerulus at least as well as tradition inshore diver-serviced crevice collectors
- Can be handled safely by normal commercial lobster crew with normal lobster vessel deck equipment

Additional materials developed under this project included:

- Engineering plans for the collector design (as sent to New Zealand for successful industry deployment trials conducted in 2017) (Appendix 3)
- Deployment, servicing, sample handling, and materials safety information for participating lobster vessels (Appendix 4)

# Appendices

## Appendix 1: Intellectual property

This research is for the public domain. This report and any resulting manuscripts are intended for wide dissemination and promotion. Plans are available for the deep water collector design developed by this project and can be distributed to interested parties. The schematic for the camera system is published within this report. All data and statistics presented conform to confidentiality arrangements.

## Appendix 2: Staff

<b>Name</b>	<b>Organisation</b>	<b>Funding</b>
Frusher, Stewart	IMAS	FRDC and in-kind
Ewing, Graeme	IMAS	FRDC and in-kind
Colquhoun, Ruari	IMAS	FRDC and in-kind
Rizzari, Justin	IMAS	FRDC and in-kind
Davey, Adam	IMAS	FRDC and in-kind

# Appendix 3 - Example graphics from the engineering plans for construction of deep water puerulus collectors

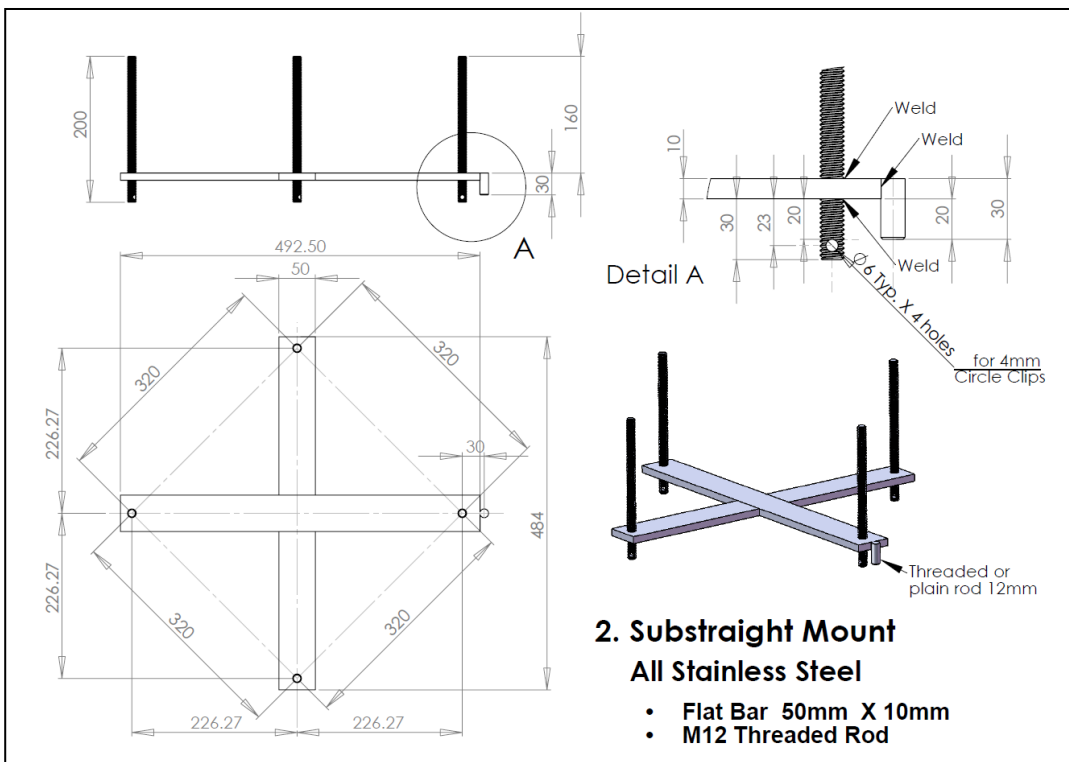
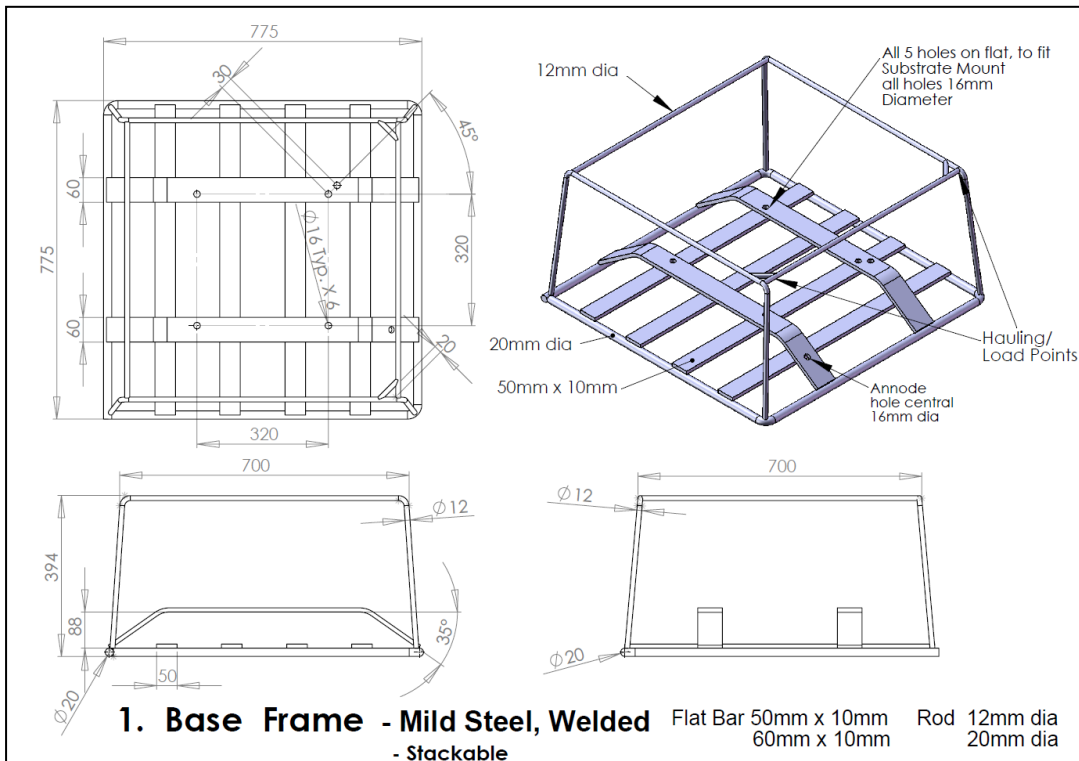

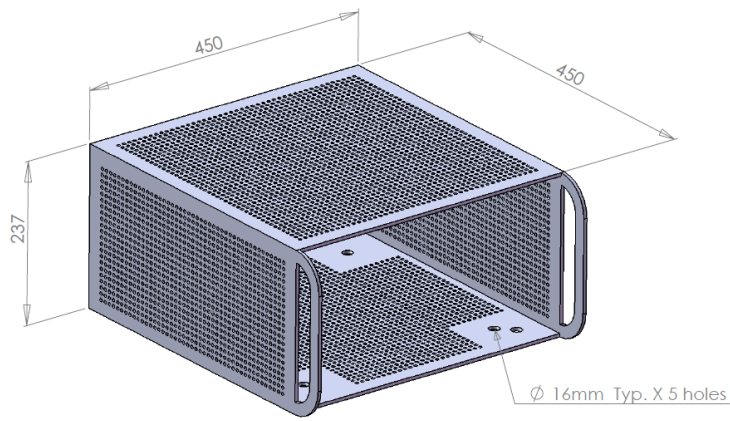

### 3. Sieve Box

**Material - HDPE - 5mm Sheet (Black)**  
(High Density Polyethylene)

1. CNC Machined/ Routed from flat sheet using DXF cad file
2. Folded into Box and Plastic Welded along edges

Sieve Box -Accompanying Drawings

- DXF file for CNC machining
- Dimensioned drawing of CNC machining

### Puerulus Collector General Assembly Drwg No. 5

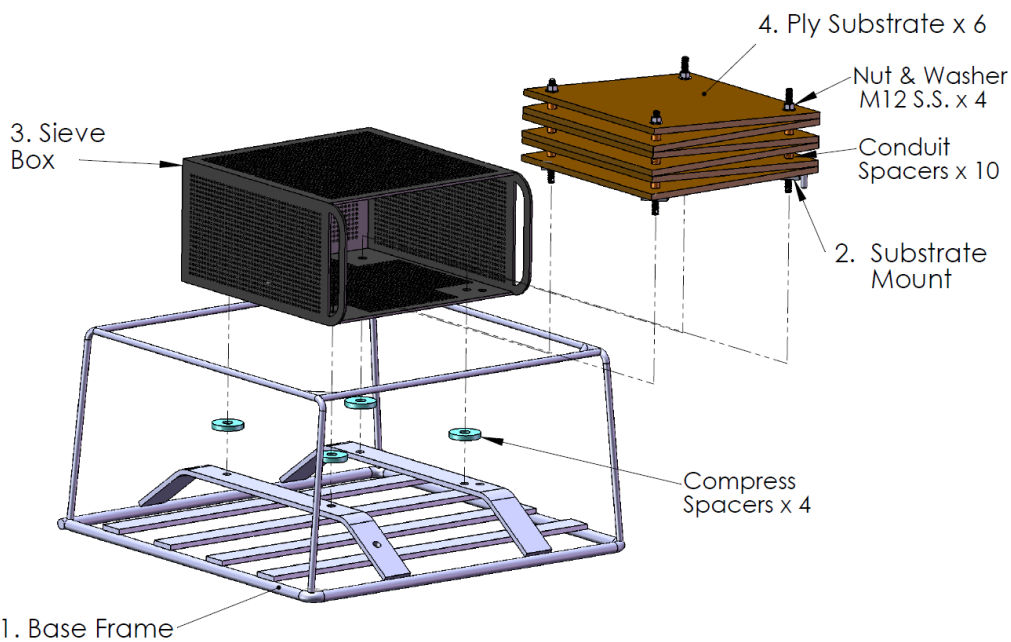

# Appendix 4 – Data sheets and instructions supplied to participating fishers

## Wheelhouse data sheet

Date	Time	Deploy or Retrieve?	Position double buoy	Position single buoy	Depth (F or M)	Collector numbers	Jar labels	Number of puerulus	Old or new	Collector condition/Comments
1/01/2016	13:05	R	43° 5.225' 147° 25.025'	43° 5.245' 147° 25.026'	55m	4-6	NE01904	2	Old	Anode 75% some corrosion around pin holes in base, moderate fouling on line, minor fouling on mesh box



## Servicing Instructions

### Where to deploy

- Deploy in 4 strings, each with 3 traps
- 2 strings in approx. 50m, 2 string in approx. 100m
- Onto soft bottom
- >1nm from reef
- Where possible without significant reef to seaward

### Deploy details for each string

- Date and time
- Position of both ends
- Trap numbers
- Depth
- Report position to [Graeme.Ewing@utas.edu.au](mailto:Graeme.Ewing@utas.edu.au) so I can arrange notice to mariners

### Haul details for each string

- Haul  $\geq$  monthly over summer and autumn
- Date and time
- Position of the double buoy
- Trap numbers
- Collector condition (corrosion/anode, fouling, pins)
- Line/buoy fouling

### Minimising the loss of pueruli

- Haul the collectors from the double buoyed end
- Haul slowly to minimise turbulence
- Minimise flushing at the surface
- Keep the opening of the sieve box facing up

### Service the collector

- Remove pins and extract sieve box with collector
- Remove collector from sieve box and place in sieved bin
- Check sieve box for animals
- Carefully remove all animals from collector using old saw and deck hose
- Check the sieved bin for pueruli
- Retain ALL animals in preservative in jars (don't overfill jars)
- Uniquely label jars (eg. NE01#03 to signify collector #3 from the first NE servicing event)
- Clean fouling from the collector
- Replace clips if necessary
- Re-deploy

### Preserving animals

- Don't add animals beyond overflowing the jar
- Ideally retain ALL animals. If this isn't possible retain all crustaceans and photograph larger animals in the sieve box next to the labelled jar lid

## Appendix 5: Species list from fauna retained from collector servicing

Taxa	Family	Species	February 2016				August 2016			
			NW	NE	SE	SW	NW	NE	SE	SW
Pycnogonida	Pycnogonida	Pycnogonid sp.1	0	0	2	0	0	0	0	0
Pycnogonida	Pycnogonida	Pycnogonid sp.2	0	0	0	0	0	0	0	1
Asciacea	Asciacea	cf. Ascidiella aspersa	58	0	0	0	0	0	0	0
Terebratulida (O.)	Terebratulida (O.)	Brachiopod sp.	0	0	1	0	0	0	0	0
Amphipoda	Eusiridae	Eusirid sp.	0	0	13	0	0	0	0	0
Amphipoda	Isaeidae	Isaeidae	0	0	42	0	0	0	0	1
Amphipoda	Lysianassidae	Lysianassid sp.	0	0	5	0	0	0	0	0
Amphipoda	?Iciliidae	?Iciliid sp.	0	0	1	0	0	0	0	0
Amphipoda	Podoceridae	Podocericid sp.1	0	0	2	0	0	0	0	0
Amphipoda	Podoceridae	Podocericid sp.2	0	0	1	0	0	0	0	0
wBrachyura	Dromiidae	Dromia wilsoni	3	0	0	0	1	0	0	0
Brachyura	Hymenosomatidae	Halicarcinus ovatus	1	0	3	0	0	0	0	0
Brachyura	Leucosiidae	Leucosiid sp.	0	0	0	0	0	1	0	0
Brachyura	Majidae	Majid sp.	0	0	4	2	0	0	4	0
Brachyura	Portunidae	Nectocarcinus tuberculosus	0	0	7	1	0	0	0	0
Brachyura	Porcellanidae	Petrocheles australiensis	0	0	0	1	0	0	0	0
Brachyura	Pilumnidae	Pilumnus tomentosus	1	1	0	0	0	8	0	0
Brachyura	Pilumnidae	Pilumnid sp.	2	0	0	0	0	0	0	0
Brachyura	Xanthidae	Actaea peronii	0	0	0	0	1	0	0	0
Amphipoda	Caprellidae	Orthoprotella tasmaniensis	0	0	18	2	0	0	0	0
Amphipoda	Caprellidae	Caprella sp.	0	0	33	0	0	0	0	0
Decapoda	Palaemonidae	Periclimenes yaldwyni	3	13	15	26	13	6	2	13
Decapoda	Palaemonidae	Palaemonid sp.	10	0	109	67	4	0	4	1
Decapoda	Decapoda	Decapoda	0	0	1	0	0	0	1	0
Decapoda	Decapoda	Decapoda	0	1	5	0	0	0	0	0
Decapoda	Alpheidae	Synalpheus sp.	21	0	1	0	2	0	0	0
Amnomura	Galatheididae	Phylladiorhynchus pusillus	1	1	0	0	2	1	0	0
Decapoda	Palinuridae	Jasus edwardsii	0	0	0	0	1	0	0	0
Decapoda	Rhynchocinetidae	Rhynchocinetes cf. australis	0	0	0	0	6	0	0	0
Decapoda	Alpheidae	Alpeid sp.	0	0	0	0	1	0	0	0
Iosopoda	Sphaeromatidae	Neosphaeroma sp.	0	0	8	6	0	0	0	0
Iosopoda	cf. Cymothoidae	cf. Cymothoidae	0	0	1	0	0	1	0	0
Amnomura	Paguridae	Pagurix handrecki	1	5	0	2	14	23	1	26
Amnomura	Diogenidae	Strigopagurus strigimanus	0	2	6	0	0	15	7	0
Amnomura	Diogenidae	Diogenid sp.	0	0	0	0	0	1	0	0
Crinoidea	Crinoidea	Crinoid sp.	0	0	1	0	0	0	0	0
Ophiuroidea	Ophiuroidea	Ophiuroid sp.	0	0	0	2	0	0	0	0
Ophiuroidea	Ophiotrichidae	Ophiotrix cf. caespitosa	0	1	0	1	0	0	0	1
Cephalopoda	Octopodidae	Macroctopus maorum	0	0	0	0	0	0	0	1
Opisthobranchia	Pleurobranchaeidae	Pleurobranchaea maculata	0	0	4	7	0	0	0	0
Opisthobranchia	Opisthobranchia	Opisthobranch sp.	0	0	1	0	0	0	0	0
Gastropoda	Turridae	Turrid sp.	0	0	0	0	0	0	0	1
Gastropoda	Ranellidae	Ranella australasia	0	0	0	0	1	0	0	2
Gastropoda	Turritellidae	Maoricolpus roseus	0	0	0	0	0	2	0	0
Bivalvia	Mytilidae	Musculus impactus	0	0	0	0	1	0	0	0
Bivalvia	Pectinidae	Talochlamys pulleineana	0	0	0	0	0	0	0	1
Bivalvia	Pectinidae	Pectinid sp.	0	0	0	0	0	1	0	0
Polychaeta	Sabellidae	Branchiomma cf. nigromaculata	0	0	0	0	0	1	0	0
Polychaeta	Serpulid sp.	Serpulid sp.	0	0	0	0	2	0	0	0
Polychaeta	Eunicidae	Eunice bassensis	0	0	0	0	0	0	0	1
Polychaeta	Oeononidae	Oeononid sp.	0	0	0	0	1	0	0	0
Polychaeta	Amphinomidae	Amphinomid sp.	1	0	0	0	0	0	0	0
Polychaeta	Polychaeta	Polychaeta	0	0	0	0	0	0	0	1

## Appendix 6: References

- R Core Team, 2017. R: a language and environment for statistical computing. . R Foundation for Statistical Computing, Vienna, Austria.
- Baker, E., 2017. The hot, the cold, and the in between – let’s talk temperatures! . Hook, Line and Thinker. Fishermen and Scientists Research Society, Canada, pp. 5-8.
- Barrett, N., Buxton, C., Gardner, C., 2009. Rock lobster movement patterns and population structure within a Tasmanian Marine Protected Area inform fishery and conservation management. *Marine & Freshwater Research* 60, 417-425.
- Booth, J., Phillips, B., 1994. Early life history of spiny lobster. *Crustaceana* 66, 271-294.
- Booth, J.D., 1997. Long-distance movements in *Jasus* spp. and their role in larval recruitment. Rosenstiel School of Marine and Atmospheric Science, pp. 111-128.
- Booth, J.D., 2001. Habitat preferences and behaviour of newly settled *Jasus edwardsii* (Palinuridae). *Marine and Freshwater Research* 52, 1055-1065.
- Booth, J.D., Carruthers, A.D., Bolt, C.D., Stewart, R.A., 1991. Measuring depth of settlement in the red rock lobster, *Jasus edwardsii*. *New Zealand Journal of Marine and Freshwater Research* 25, 123-132.
- Booth, J.D., Tarring, S.C., 1986. Settlement of the red rock lobster, *Jasus edwardsii* , near Gisborne, New Zealand. *New Zealand Journal of Marine and Freshwater Research* 20, 291-297.
- Bruce, B., Bradford, R., Griffin, D., Gardner, C., Young, J., 2000. A synthesis of existing data on larval rock lobster distribution in southern Australia. FRDC Final Report, 96/107. CSIRO, Hobart.
- Butler, M.J., MacDiarmid, A.B., Booth, J.D., 1999. The cause and consequence of ontogenetic changes in social aggregation in New Zealand spiny lobsters. *Marine Ecology Progress series* 188, 179-181.
- Caputi, N., Lestang, S., Frusher, S., Wahle, R.A., 2013. The Impact of Climate Change on Exploited Lobster Stocks. *Lobsters: Biology, Management, Aquaculture and Fisheries*. John Wiley & Sons, Ltd, pp. 84-112.
- Cohen, P.J., Gardner, C., 2007. Regional Patterns in Puerulus Catches from Eastern and Western Tasmania. *Journal of Crustacean Biology* 27, 592-596.
- Cruz, R., Diaz, E., Baez, M., Adriano, R., 2001. Variability in recruitment of multiple life stages of the Caribbean spiny lobster, *Panulirus argus*, in the Gulf of Batabano, Cuba. *Marine and Freshwater Research* 52, 1263-1270.
- Dennis, D., Ye, Y., Pitcher, R., Skewes, T., 2004. Ecology and stock assessment of the ornate rock lobster *Panulirus ornatus* population in Torres Strait, Australia. In: Williams, K. (Ed.), *Spiny lobster ecology and exploitation in the South China Sea region*, Institute of Oceanography, Nha Trang, Vietnam, pp. 29-40.
- Edmunds, M., 1995. The ecology of the juvenile southern Rock Lobster, *Jasus edwardsii* (Hutton 1875)(Palinuridae). PhD thesis, School of Zoology. University of Tasmania, Hobart, p. 164.
- Ewing, G., Frusher, S., Sharman, C., Treloggen, R., 2013. Developing cost-effective industry based techniques for monitoring puerulus settlement in all conditions: trials in southern and western Tasmania - Phase 1: Proof of concept (2011/020). FRDC Final Report. IMAS, Hobart, p. 50.
- Frusher, S., Prescott, J., Edmunds, M., 1999. Southern Rock Lobsters. In: Andrew, N. (Ed.), *Under Southern Seas, The Ecology of Australia's Rocky Reefs*. UNSW Press, Sydney, pp. 107-113.
- Gardner, C., Frusher, S., Barrett, N., Haddon, M., Buxton, C., 2006. Spatial variation in size at onset of maturity of female southern rock lobster *Jasus edwardsii* around Tasmania, Australia. *Scientia Marina* 70, 423-430.

- Gardner, C., Frusher, S., Haddon, M., Buxton, C., 2003. Movements of the southern rock lobster *Jasus edwardsii* in Tasmania, Australia. *Bulletin of Marine Science* 73, 653-671.
- Gardner, C., Frusher, S.D., Kennedy, R.B., Cawthorn, A., 2001. Relationship between settlement of southern rock lobster pueruli, *Jasus edwardsii*, and recruitment to the fishery in Tasmania, Australia. *Marine and Freshwater Research* 52, 1271-1275.
- George, R.W., 2005. Evolution of life cycles, including migration, in spiny lobsters (Palinuridae). S I R Publishing, P.O. Box 399 Wellington New Zealand, [URL:<http://www.rsnz.govt.nz/>], pp. 503-514.
- Green, B., Gardner, C., Linnane, A., Hobday, D., Chadrapavan, A., Punt, A., McGarvey, R., Hartman, K., Treloggen, R., Revill, H., Hoare, M., Hawthorne, P.J., 2012. Spatial management of southern rock lobster fisheries to improve yield, value and sustainability. FRDC Final Report, 2006/220. IMAS, Hobart.
- Groeneveld, J.C., Greengrass, C.L., van Zyl, D.L., Branch, G.M., 2010. Settlement patterns, size and growth of puerulus and juvenile rock lobster *Jasus lalandii* at an oyster farm in Saldanha Bay, South Africa. *African Journal of Marine Science* 32, 501-510.
- Guzman-del Proo, S.A., Carrillo-Laguna, J., Belmar-Perez, J., Villa, B.A., 1996. The puerulus settlement of red spiny lobster (*Panulirus interruptus*) in Bahia Tortugas, Baja California, Mexico. *Crustaceana* 69, 949-957.
- Harris, G., Nilsson, C., Clementson, L., Thomas, D., 1987. The water masses of the east coast of Tasmania: Seasonal and interannual variability and the influence on phytoplankton biomass and productivity. *Australian Journal of Marine and Freshwater Research* 38, 569-590.
- Hartman, K., Gardner, C., Hobday, D., 2012. Fishery Assessment Report - Tasmanian Rock Lobster Fishery 2010/11. Institute for Marine and Antarctic Studies, Hobart.
- Hinojosa, I., Gardner, C., Green, B., Jeffs, A., León, R., Linnane, A., 2016a. Differing environmental drivers of settlement across the range of southern rock lobster (*Jasus edwardsii*) suggest resilience of the fishery to climate change. *Fisheries Oceanography* 26, 49-64.
- Hinojosa, I., Green, B., Gardner, C., Hesse, J., Stanley, J., Jeffs, A., 2016b. Reef Sound as an Orientation Cue for Shoreward Migration by Pueruli of the Rock Lobster, *Jasus edwardsii*. *PLOS One* 11, 1-15.
- Hinojosa, I., Green, B., Gardner, C., Jeffs, A., 2015. Settlement and early survival of southern rock lobster, *Jasus edwardsii*, under climate-driven decline of kelp habitats. *ICES Journal of Marine Science* 72, 59-68.
- Ibbott, S., Gardner, C., 2002. Looking at macroalgae habitat change and its effect on lobster settlement. *The Lobster Newsletter* 15, 2-3.
- Jeffs, A.G., Chiswell, S.M., Booth, J.D., 2001. Distribution and condition of pueruli of the spiny lobster *Jasus edwardsii* offshore from north-east New Zealand. *Marine & Freshwater Research* 52, 1211-1216.
- Kanciruk, P., 1980. Ecology of juvenile and adult Palinuridae (Spiny lobsters). In: Phillips, B., Kittaka, J. (Eds.), *Spiny lobsters: fisheries and culture*. Fishing News Books, London, pp. 59-96.
- Kelly, S., 2001. Temporal variation in the movement of the spiny lobster *Jasus edwardsii*. *Marine and Freshwater Research* 52, 323-331.
- Kelly, S., MacDiarmid, A.B., 2003. Movement patterns of mature spiny lobsters, *Jasus edwardsii*, from a marine reserve. *New Zealand Journal of Marine and Freshwater Research* 37, 149-158.
- Kennedy, R.B., 1991. Juvenile crays: where do they settle and when? , *Fishing Today*, Hobart, pp. 22-23.
- MacDiarmid, A.B., Hickey, B., Maller, R.A., 1991. Daily movement patterns of the spiny lobster *Jasus edwardsii* (Hutton) on a shallow reef in northern New Zealand. *Journal of Experimental Marine Biology and Ecology* 147, 185-205.

- Miller, D.L., Goodwin, M.H., 1989. Summary of Bermuda spiny lobster workshop and workshop follow-up.
- Mills, D., Crear, B., 2004. Developing a cost-effective puerulus collector for the southern rock lobster (*Jasus edwardsii*) aquaculture industry. *Aquacultural Engineering* 31, 1-15.
- Norman, C.P., Morikawa, Y., 1996. Rock face incline and height above sea bed of holes used as shelters by pueruli and juvenile Japanese spiny lobsters *Panulirus japonicus*. *Crustacean research*. Tokyo, 121-128.
- Phillips, B., 1983. Migrations of pre-adult western rock lobsters, *Panulirus cygnus*, in Western Australia. *Marine Biology* 76, 311-318.
- Phillips, B., McWilliam, P.S., 1986. The pelagic phase of spiny lobster development. *Canadian Journal of Fisheries and Aquatic Sciences* 43, 2153-2163.
- Phillips, B., Melville-Smith, R., Thomson, A., Rossbach, M., 2007. Assessing the possibilities for the natural settlement of western rock lobster. *WA Fish.*, Perth, W.A. (Australia).
- Phillips, B.F., 1972. A semi-quantitative collector of the puerulus larvae of the western rock lobster *Panulirus longipes cygnus* George (Decapoda, Panuliridea [sic] ). *Crustaceana* 22, 147-154.
- Phillips, B.F., Booth, J.D., 1994. Design, use, and effectiveness of collectors for catching the puerulus stage of spiny lobsters. *Reviews in Fisheries Science* 2, 255-289.
- Phillips, B.F., Cheng, Y.W., Cox, C., Hunt, J., Jue, N.K., Melville-Smith, R., 2005. Comparison of catches on two types of collector of recently settled stages of the spiny lobster (*Panulirus argus*), Florida, United States. *New Zealand Journal of Marine and Freshwater Research* 39, 715-722.
- Phillips, B.F., Melville-Smith, R., Cheng, Y.W., Rossbach, M., 2001. Testing collector designs for commercial harvesting of western rock lobster (*Panulirus cygnus*) puerulus. CSIRO Publishing, PO Box 1139 150 Oxford Street Collingwood Vic. 3066 Australia, [URL:<http://www.publish.csiro.au/journals/mfr/>], pp. 1465-1473.
- Polovina, J.J., Haight, W.R., Moffitt, R.B., Parrish, F.A., Kittaka, J., 1995. The role of benthic habitat, oceanography, and fishing on the population dynamics of the spiny lobster, *Panulirus marginatus* (Decapoda, Palinuridae), in the Hawaiian Archipelago. *Crustaceana*, 4. International Workshop on Lobster Biology and Management, 1993, Sanriku (Japan), 1993, pp. 203-212.
- Serfling, S.a.F., R., 1975. Ecological studies of the Puerulus Larval stage of the California spiny lobster, *Panulirus Interruptus*. *Fisheries Bulletin* 73, 360-377.
- Venables, W.N., Ripley, B.D., 2003. *Modern Applied Statistics with S*. Springer New York.
- Witham, R., Ingle, R., Joyce, E., 1968. Physiological and ecological studies of *Panulirus argus* from the St. Lucie Estuary. Florida Board of Conservation Marine Laboratory Technical Series 53, 31.
- Ziegler, P.E., Johnson, C.R., Frusher, S., Gardner, C., 2002. Catchability of the southern rock lobster *Jasus edwardsii*. II. Effects of size. *Marine and Freshwater Research* 53, 1149-1159.

## Appendix 7: Review of puerulus collectors

Numerous materials have been utilised to simulate desirable habitat for puerulus settlement for the purposes of monitoring recruitment variability and for commercial harvest for mariculture. A selection of collector designs that have yielded high rates of puerulus settlement in the coastal waters of countries including Australia, New Zealand, United States, Mexico, Japan, India and Cuba, are summarised below.

- i. **Plate crevice collectors** are constructed with 16 squares of plywood, held in a galvanised steel frame with bolts in the corners and PVC conduit spacers producing 15 wedge-shaped crevices suitable. Plate crevice collectors fixed rigidly to the seafloor on moorings have successfully collected puerulus for inshore puerulus settlement monitoring programs in southern Australia and New Zealand (Booth and Tarring, 1986; Gardner *et al.*, 2001) (Fig. 1a). Floating tethered crevice collectors were also successful in collecting puerulus in commercial harvest trials (Mills and Crear, 2004) (Fig. 1b).
- ii. **Mesh collectors** are comprised of mesh enclosures containing natural or artificial strata that provides complex convoluted habitat suitable for puerulus settlement. Mesh cylinders or bags of plastic oyster mesh filled with heavy trawl mesh or Black wind-break mesh were successful in collecting pueruli in research into commercial harvest of puerulus (Mills and Crear, 2004) (Fig. 1c). Nylon bags containing surf-grass and red algae were also successful in collecting pueruli in California (Serfling, 1975).
- iii. **Witham-style collectors** are constructed of leaves of fibrous material folded over horizontal rails and buoyed at the surface. Each leaf supports a matrix of filaments composed of nylon, vinyl (Witham *et al.*, 1968) (Fig. 1d), or hogs hair (Miller and Goodwin, 1989) and pueruli settle in the gaps between the leaves. Witham collectors have successfully collected puerulus in Florida, Hawaii, and the Caribbean (Phillips and Booth, 1994).
- iv. **Phillips collectors** consist of three vertically mounted rectangular plates arranged in a vertical prism and buoyed to just reach the sea surface. Each plate has 25 polypropylene tassels simulating seagrass or kelp and providing structured habitat for settlement (Phillips, 1972) (Fig. 1e). Phillips collectors have been used in Western Australia (Phillips and Booth, 1994) and Cuba (Cruz *et al.*, 2001) to collect puerulus.
- v. **Sandwich collectors**, a modified version of the Phillips collector, consisting of 2 sheets of grey industrial PVC with bales of tassels attached to the outside of the sheets (Fig. 1f). Sandwich collectors have been shown to be highly effective in collecting puerulus (Phillips *et al.*, 2001; Phillips *et al.*, 2005).

- vi. **GuSi collectors** are an inexpensive puerulus collector constructed of bands of synthetic strapping, frayed to form tassels, and wound around a 19L plastic bucket (Fig. 1g). This collector has been used to study puerulus settlement in Mexico (Guzman-del Proo *et al.*, 1996).
- vii. **Bottlebrush collectors** are comprised of stacked rosettes of black wind-break mesh on a central shaft. These collectors are inexpensive and successfully collected pueruli in commercial collection trials (Mills and Crear, 2004) (Fig. 1h).
- viii. **Aerated concrete blocks** (Hebel with an array of drilled holes, have been shown to provide refugia for pueruli (Edmunds, 1995; Dennis *et al.*, 2004) (Fig. 1i).

Designs that successfully collect puerulus include complex habitat in either rigid material (crevice, sandwich and block collectors) or convoluted flexible material (mesh, Witham, GuSi, and bottlebrush collectors). Consequently, the primary function of the collector seems to be to provide shelter. Weed or weed-like material correlates with higher rates of settlement (Ibbott and Gardner, 2002), and a number of collector designs incorporate this feature (mesh, Witham, Phillips, GuSi, and bottlebrush collectors). This suggests that pueruli may be seduced from the water column by suspended weed due to the likelihood that weed is anchored to hard substrate that may provide shelter. This explanation is supported by higher densities of pueruli in holes adjacent to stems and holdfasts of algae (Norman and Morikawa, 1996).

Successful collector designs will first encourage settlement and subsequently retain settled pueruli. The desirability of a collector design appears to vary among species, with *Panulirus* spp. preferring weed-type shelter and *Jasus* spp. preferring crevice-type shelter (Phillips and Booth, 1994), although this trend is not unequivocal (Mills and Crear, 2004). Further, the most appropriate collector is also likely to depend on other factors such as the coastal features where the collectors are deployed (Phillips and Booth, 1994). Booth (2001) conducted laboratory tank experiments on the habitat preferences of *J. edwardsii* pueruli and concluded that they prefer refuges with firm surfaces over soft, conditioned over unconditioned, horizontal openings over vertical, and rough surfaces over smooth.

Comparisons in New Zealand, South Australian and Tasmanian waters yielded equal or higher numbers of *J. edwardsii* settlers in crevice collector (rigid horizontal refuge), than in Phillips simulated seaweed collectors (soft flexible refuge) (Kennedy, 1991; Phillips and Booth, 1994). However, Mills and Crear (2004) found that *J. edwardsii* settled on a variety of materials, including flexible strata, some bearing little resemblance to features in their natural habitat. Palinurid lobster rearing trials conducted at the IMAS laboratories have found that puerulus and early juveniles also utilise FRP grid mesh for shelter (Fig. j).

The crevice puerulus collectors used in shallow inshore Tasmanian waters are manually “bagged” in fine mesh sacks by divers prior to being hauled to the surface to eliminate losses of puerulus in the water column. Research in shallow inshore Tasmanian waters has shown that losses of puerulus from un-bagged collectors are minimal (Mills and Crear, 2004). However, retrieval of collectors from deep water, and particularly the potential for flushing at the surface under adverse sea conditions, may lead to significant losses of puerulus. Consequently, minimising the loss of puerulus during retrieval must also be considered in the assessment of potential collector systems for deep water.



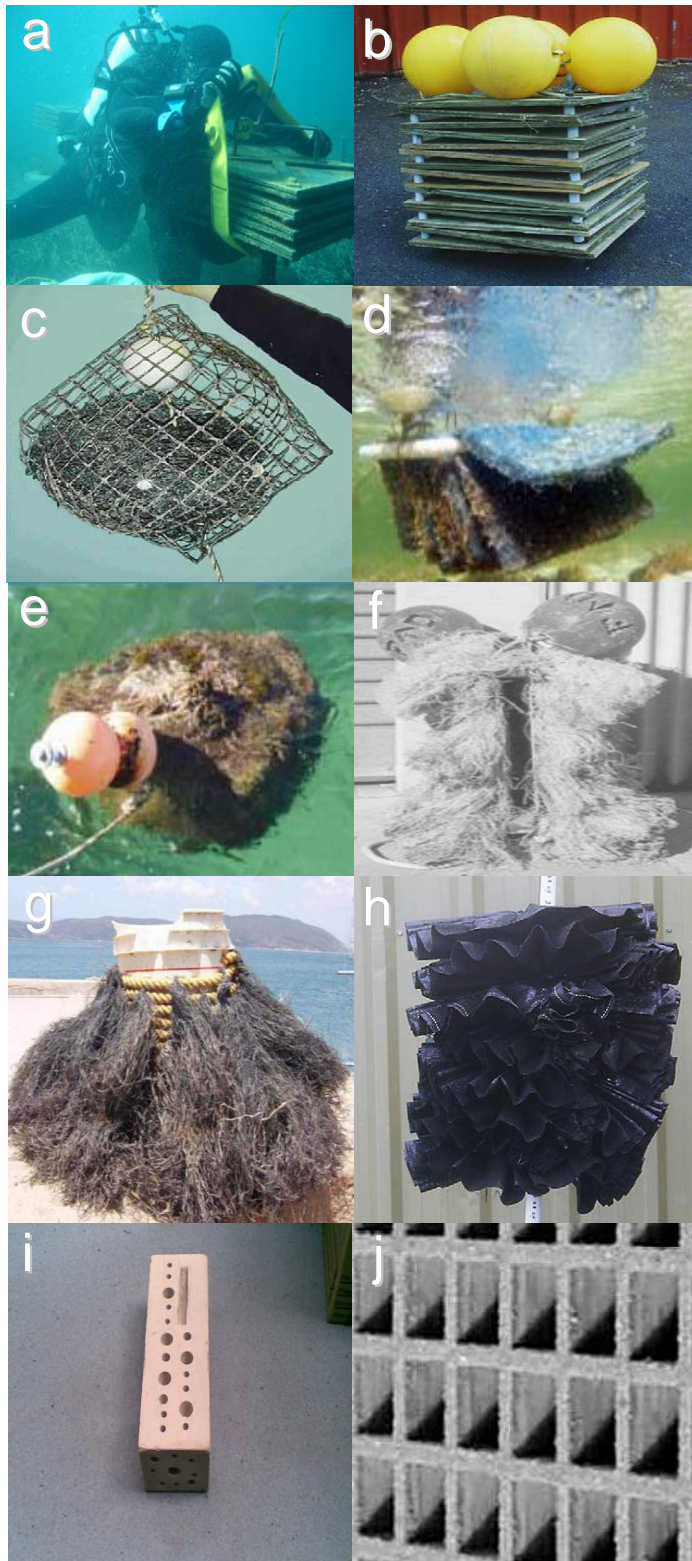

Figure 1: Collector materials and designs known to successfully collect puerulus (a - crevice; b – floating crevice; c – mesh bag; d – Witham; e – Phillips; f – sandwich ; g – GuSi; h – bottlebrush; i – Hebel; j – FRP gridmesh).



## Appendix 8: Industry workshop

### Outcomes from deep-water puerulus project workshop – 28/2/2012

#### Attendees

Brendan Taylor – Fisher  
Kent Way – Fisher  
Neil Stump – TSIC  
Chris Sharman – CSIRO  
Stewart Frusher – IMAS  
David Faloon – IMAS  
Graeme Ewing - IMAS

#### Project background and need

In Australia, lobster larval (puerulus) collectors have been deployed to observe larval settlement and to improve our understanding of the relationship between recruitment, future catches and short and long term recruitment trends. Puerulus collectors are serviced by divers (SA, Tas & Vic) and from dinghies (WA) and consequently, collector sites have been limited to shallow inshore waters, and to a small number of locations. Given that the majority of the catch in the Tasmanian southern rock lobster fishery (*Jasus edwardsii*) is taken from deeper waters and from the southern and western regions, where no collectors have been successfully deployed, there is a need to develop a cost-effective method of deploying and servicing collectors in deeper water to improve spatial (region and depth) coverage. This need was recognised in a review of the puerulus program undertaken in 2008 that involved government and industry and identified the priority to investigate options for puerulus collection on the west coast using the commercial fleet to reduce costs.

This is phase 1, of a 3 phase project with the ultimate aim to develop cost-effective collectors that can be used to provide an early warning of changes in puerulus settlement that can be used to improve management of the fishery. Such collectors will need to withstand all weather conditions, be serviced in deeper water and be serviced by the fishing industry throughout southern Australia.

The project will also investigate the potential of an underwater camera system to monitor settlement. An underwater camera and transmission system, being developed for other applications by CSIRO ICT Centre, will relay pictures to the IMAS laboratory and will be evaluated for reducing puerulus monitoring costs and for improving our knowledge of puerulus settlement and thus recruitment to the fishery. As photos will be taken over 24 hours each day, we will also be able to investigate puerulus settlement behaviour, such as whether puerulus arrive in groups or individually, their retention time on collectors, and the reliability of monthly puerulus counts as a measure of settlement activity. This information is expected to aid in refining the relationship between observed puerulus settlement and future predicted catches for the fishery.

#### Collector design for deep water collection of *J. edwardsii* puerulus in Tasmanian waters

This study aims to develop and trial designs of collectors for monitoring puerulus settlement in deep water on the coast of Tasmania that are suitable for deployment, retrieval and servicing by vessels from the commercial lobster fleet. Each puerulus collector design will incorporate settlement strata (which provides a desirable habitat), a collector base on which to mount settlement strata on the seafloor, a means of retrieval such as buoy-line and surface buoy, and possibly, additional mooring material to ensure that the collectors remain stationary on the seafloor.

The crevice puerulus collectors used in shallow inshore Tasmanian waters are manually “bagged” in fine mesh sacks by divers prior to being hauled to the surface to eliminate losses of puerulus in the water column. Research in shallow inshore Tasmanian waters has shown that losses of puerulus from un-bagged collectors are minimal (Mills and Crear, 2004). However, retrieval of collectors from deep water, and particularly the potential for flushing at the surface under adverse sea conditions, may lead to significant losses of puerulus. Consequently, minimising the loss of puerulus during retrieval has also been considered in the assessment of potential collector systems.

**Settlement substrata**

Considerations for the selection of settlement strata for monitoring settlement of puerulus in deep water include maximising settlement rates and precision, minimising loss of settled pueruli due to flushing on retrieval, ease and safety of servicing on deck, minimising the volume and weight of materials required for servicing, and minimising cost. Table 1 summarises the relative advantages and disadvantages of various settlement strata.